

STIHL

STIHL MSE 170 C, 190 C, 210 C, 230 C

Instruction Manual



Contents

Guide to Using this Manual	2	Maintenance and Care	36
Safety Precautions	2	Minimize Wear and Avoid Damage	37
Reactive Forces	7	Main Parts	38
Working Techniques	9	Specifications	39
Packing List	17	Ordering Spare Parts	41
Cutting Attachment	18	Maintenance and Repairs	42
Mounting the Bar and Chain (side chain tensioner)	18	Disposal	42
Mounting the Bar and Chain (quick chain tensioner)	19	EC Declaration of Conformity	42
Tensioning the Saw Chain (side chain tensioner)	21	General Power Tool Safety Warnings	43
Tensioning the Saw Chain (quick chain tensioner)	22		
Checking Chain Tension	22		
Chain Lubricant	22		
Filling Chain Oil Tank	23		
Checking Chain Lubrication	25		
Coasting Brake	25		
Chain Brake	25		
Connecting to Power Supply	26		
Switching On	27		
Switching Off	27		
Overload Cutout	28		
Operating Instructions	29		
Taking Care of the Guide Bar	30		
Motor Cooling	30		
Storing the Machine	31		
Checking and Replacing the Chain Sprocket	31		
Maintaining and Sharpening the Saw Chain	32		

Dear Customer,

Thank you for choosing a quality engineered STIHL product.

It has been built using modern production techniques and comprehensive quality assurance. Every effort has been made to ensure your satisfaction and trouble-free use of the product.

Please contact your dealer or our sales company if you have any queries concerning this product.

Your



Dr. Nikolas Stihl

STIHL

This instruction manual is protected by copyright. All rights reserved, especially the rights to reproduce, translate and process with electronic systems.

Guide to Using this Manual

This instruction manual covers a STIHL electric chain saw which is also referred to as the saw, power tool or machine in the descriptions.

Pictograms

The meanings of the pictograms attached to the machine are explained in this manual.

Depending on the model concerned, the following pictograms may be attached to your machine.



Chain oil tank; chain oil



Direction of chain rotation



Tension the chain



Thermal overload cutout



Unlock



Lock

Symbols in text



WARNING

Warning where there is a risk of an accident or personal injury or serious damage to property.



NOTICE

Caution where there is a risk of damaging the machine or its individual components.

Engineering improvements

STIHL's philosophy is to continually improve all of its products. For this reason we may modify the design, engineering and appearance of our products periodically.

Therefore, some changes, modifications and improvements may not be covered in this manual.

Safety Precautions



Special safety precautions must be observed to reduce the risk of personal injury when working with a chain saw because of the very high chain speed and very sharp cutters.



It is important that you read the instruction manual before first use and keep it in a safe place for future reference. Non-observance of the instruction manual may result in serious or even fatal injury.

General

Observe all applicable local safety regulations, standards and ordinances.

The use of noise emitting power tools may be restricted to certain times by national or local regulations.

If you have not used this model before: Have your dealer or other experienced user show you how to operate your unit or attend a special course in its operation.

Minors should never be allowed to use a chain saw.

Keep bystanders, especially children, and animals away from the work area.

The user is responsible for avoiding injury to third parties or damage to their property.

Do not lend or rent your chain saw without the instruction manual. Be sure that anyone using it understands the information contained in this manual.

Persons who are not able to operate the power tool safely due to limited physical, sensory or mental ability may work with it only under supervision or after instruction by a responsible person.

To operate a chain saw you must be rested, in good physical condition and mental health. If you have any condition that might be aggravated by strenuous work, check with your doctor before operating a chain saw.

Do not operate the chain saw if you are under the influence of any substance (drugs, alcohol) which might impair vision, dexterity or judgment.

To reduce the risk of accidents or injury, put off the work in poor weather conditions (rain, snow, ice, wind).

Intended Use

The chainsaw may be used for cutting wood and wooden objects only. It is particularly suitable for cutting firewood and other woodworking projects close to the house.

It must not be used for any other purpose because of the increased risk of accidents.

Never attempt to modify your saw in any way since this may increase the risk of personal injury. STIHL excludes all liability for personal injury and damage to property caused while using unauthorized attachments.

Clothing and Equipment

Wear proper protective clothing and equipment.



Clothing must be sturdy but allow complete freedom of movement. Wear snug-fitting clothing with **cut retardant inserts** – do not wear a work coat.

Avoid clothing that could get caught on branches or brush or moving parts of the saw. Do not wear a scarf, necktie or jewelry. Tie up and confine long hair (e.g. with a hair net, cap, hard hat, etc.).



Wear **suitable footwear** with cut retardant inserts, non-slip soles and steel toe.



WARNING



To reduce the risk of eye injuries, wear close-fitting safety glasses in accordance with European Standard EN 166. Make sure the safety glasses are a comfortable and snug fit.

Wear a face shield and make sure it is a good fit.

Hearing protection is recommended if your daily working time is more than 2.5 hours.

Wear a safety hard hat with chin strap where there is a danger of head injuries from falling objects.



Wear heavy-duty work gloves made of durable material (e.g. leather).

STIHL offers a comprehensive range of personal protective clothing and equipment.

Transporting

Always switch off the chainsaw before carrying it – even for short distances, disconnect the plug from the wall outlet, move the hand guard to  and fit the chain scabbard. This avoids the risk of the motor starting unintentionally.

Carry your chainsaw by the front handle only with the guide bar behind you.

In vehicles: Properly secure your chainsaw to prevent turnover, chain oil spillage and damage.

Cleaning

Clean plastic surfaces with a cloth. Do not use aggressive detergents. They may damage the plastic.

Always clean dust and dirt off the chainsaw – do not use any grease solvents for this purpose.

Clean the cooling slots if necessary.

Do not use a pressure washer to clean the saw. The solid jet of water may damage parts of the saw.

Do not spray the chainsaw with water.

Accessories

Only use those tools, guide bars, chains, chain sprockets, accessories or technically equivalent components that have been approved by STIHL for this machine. If you have any questions in this respect, consult a servicing dealer. Use only high quality tools and accessories. Otherwise, there may be a risk of accidents and damage to the machine.

STIHL recommends the use of genuine STIHL tools, guide bars, chains, chain sprockets and accessories. They are specifically designed to match your model and meet your performance requirements.

Drive Gear

Electrical Connection.

The wall outlet must be equipped with a ground-fault circuit breaker or such a device must be installed between the wall outlet and the power tool – see "Connecting Saw to Power Supply".



If the connecting cord is damaged, immediately disconnect the plug from the power supply to avoid the **risk of electric shock**.

Reduce the risk of electric shock:

- Voltage and frequency of the machine (see rating plate) and the voltage and frequency of your power supply must be the same.
- Check the connecting cord, plug, extension cord and safety devices for damage. Never use damaged cords, couplings and plugs or connecting cords that do not comply with regulations.
- Always connect the power tool to a properly installed wall outlet.
- Check that the insulation of the power cord, extension cord, plug and coupling is in good condition.
- Never jerk the connecting cord to disconnect it from the wall outlet. To unplug, grasp the plug, not the cord.

Position the connecting and extension cords correctly:

- Check minimum cross section of wires (wire gauge) – see "Connecting to Power Supply".
- **To reduce the risk of stumbling**, position and mark the connecting cord so that it cannot be damaged or endanger others.
- Using unsuitable extension cords can be dangerous. Make sure the extension cord used complies with the regulations for the intended application.
- The plug and coupling of the extension cord must be water-proof and must never be immersed in water.
- Do not chafe on edges, pointed or sharp objects

- Do not squeeze through gaps in doors or windows
- If cords are twisted – unplug the power tool and straighten them out
- Always unwind the extension cord completely from the cable drum to **reduce the risk of fire from overheating**.
- The extension cord must always be behind you (i.e. the operator).
- Make sure that it cannot become entangled with branches during cutting.
- Position the connecting cord so that it cannot come into contact with the rotating chain.

Do not drive over, squash or jerk the connecting cord. Protect it from heat, oil and sharp edges.

Before Starting Work

Disconnect the plug from the wall outlet:

- before carrying out tests and adjustments or cleaning work
- when working on the cutting attachment
- before leaving your chainsaw unattended
- before transporting
- before storing
- before performing repairs and maintenance work
- in the event of danger or in an emergency

Check that your saw is properly assembled and in good condition – refer to appropriate chapters in the instruction manual.

- Check operation of chain brake, front hand guard
- Correctly mounted guide bar
- Correctly tensioned chain
- The trigger and trigger lockout must move freely and spring back to the idle position when they are released.
- Trigger is locked in position when trigger lockout is not depressed.
- Never attempt to modify the controls or safety devices in any way.
- Keep the handles dry and clean – free from oil and dirt – for safe control of the saw.
- Make sure there is sufficient chain oil in the tank.

To reduce the risk of personal injury, do not operate your saw if it is damaged or not properly assembled.

Switching On the Saw

Start the saw on level ground only. Make sure you have a firm footing. Hold the saw firmly – check that the cutting attachment is not touching any object or the ground.

The chainsaw is a one-person saw. Do not allow other persons in the work area – even when starting.

Do not attempt to switch on the saw when the saw chain is in a cut.

Switch on as described in the instruction manual.

During Operation

Make sure you always have good balance and secure footing. **To avoid slipping**, take special care when the bark is wet.

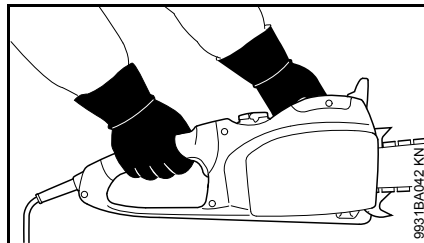

Always **hold your saw firmly with both hands**: Right hand on the rear handle, even if you are left-handed. To ensure safe control, wrap your fingers tightly around the front handle and control handle.

In case of imminent danger or in an emergency, switch off the chainsaw immediately, move hand guard to  and disconnect the plug from the wall outlet.



The drive motor is not waterproof. Never work with the power tool in the rain or in wet or very damp locations.

Do not leave your power tool out in the rain and do not operate it as long as it is damp.

Take special care in slippery conditions – damp, snow, ice, on slopes, uneven ground and freshly debarked logs.

Watch out for obstacles such as tree stumps, roots and ditches which could cause you to trip or stumble.

Do not work alone – keep within calling distance of other persons trained in first aid who can provide assistance in an emergency. Helpers at the cutting site must also wear protective clothing (hard hat) and stand well clear of the branches being cut.

Be particularly alert and cautious when wearing hearing protection because your ability to hear warnings (shouts, alarms, etc.) is restricted.

To reduce the risk of accidents, take a break in good time to avoid tiredness or exhaustion.

The dusts (e.g. sawdust), vapor and smoke produced during operation may be dangerous to health. If dust levels are very high, wear a suitable respirator.

Check the saw chain at regular short intervals during operation or immediately if there is a noticeable change in cutting behavior:

- Switch off the motor, wait for the chain to come to a standstill, disconnect the plug from the wall outlet.
- Check condition and proper mounting.
- Check sharpness.

Do not touch the chain while the chainsaw is switched on. If the chain becomes jammed by an obstacle, switch off the motor immediately and

disconnect the plug from the power supply before attempting to free the obstruction – **risk of injury**.

Before leaving your saw, switch it off, move the hand guard to  and disconnect the plug from the wall outlet to reduce the risk of the motor starting unintentionally.

To replace the saw chain, switch off the chainsaw, move hand guard to  and disconnect the plug from the wall outlet. This avoids the **risk of injury** from the motor starting unintentionally.

Your power tool is equipped with a system designed to quickly stop the saw chain – it comes to an immediate standstill as soon as you release the trigger switch – see "Coasting Brake".

Check this function at regular short intervals. Do not operate your chainsaw if the chain continues to run after you release the trigger switch – see "Coasting Brake" – **risk of injury**. Contact your servicing dealer.

Never operate your saw without proper chain lubrication – check oil level regularly during operation. Stop work immediately if the oil level is too low and refill the oil tank – see also chapters on "Filling Chain Oil Tank" and "Checking Chain Lubrication".

If your saw is subjected to unusually high loads for which it was not designed (e.g. heavy impact or a fall), always check that it is in good condition before continuing work – see also "Before Starting Work". Make sure the safety devices are working properly. Do not continue operating your saw if it is damaged. In case of doubt, consult your servicing dealer.

After Finishing Work

Switch off the saw, move the hand guard to , disconnect the plug from the wall outlet and fit the chain scabbard.

Storing

When the chainsaw is not in use, store it so that it does not endanger others. Secure it against unauthorized use.

Store your chainsaw in a dry location with the hand guard on  and the plug disconnected from the wall outlet.

Vibrations

Prolonged use of the power tool may result in vibration-induced circulation problems in the hands (whitefinger disease).

No general recommendation can be given for the length of usage because it depends on several factors.

The period of usage is prolonged by:

- Hand protection (wearing warm gloves)
- Work breaks

The period of usage is shortened by:

- Any personal tendency to suffer from poor circulation (symptoms: frequently cold fingers, tingling sensations).
- Low outside temperatures.
- The force with which the handles are held (a tight grip restricts circulation).

Continual and regular users should monitor closely the condition of their hands and fingers. If any of the above symptoms appear (e.g. tingling sensation in fingers), seek medical advice.

Maintenance and Repairs

Before carrying out any repairs, cleaning or maintenance work or work on the cutting attachment, always switch off the chainsaw, move the hand guard to  and disconnect the plug from the wall outlet. **This avoids the risk of injury** from the chain starting unintentionally.

Service the chainsaw regularly. Do not attempt any maintenance or repair work not described in the instruction manual. Have all other work performed by a servicing dealer.

STIHL recommends that you have servicing and repair work carried out exclusively by an authorized STIHL servicing dealer. STIHL dealers are regularly given the opportunity to attend training courses and are supplied with the necessary technical information.

Only use high-quality replacement parts in order to avoid the risk of accidents and damage to the saw. If you have any questions in this respect, consult a servicing dealer.

Never attempt to modify your saw in any way since this may increase the **risk of personal injury**.

Regularly check the electrical contacts and ensure that the insulation of the connecting cord and plug shows no sign of aging (brittleness).

Electrical components, e.g. power cord, may only be repaired or replaced by a qualified electrician.

Check the chain catcher and replace it if damaged.

Observe sharpening instructions – keep the chain and guide bar in good condition at all times for safe and correct handling of the machine. The chain must be properly sharpened, tensioned and well lubricated.

Always change the chain, guide bar and sprocket in good time.

Store chain lubricant in properly labeled, safety-type canisters only. Store in a dry, cool and safe location protected from light and the sun.

If there is a problem with the chain brake, switch off the saw immediately, move the hand guard to  and disconnect the plug from the wall outlet – **risk of injury**. Contact your servicing dealer – do not use your saw until the problem has been rectified (see "Chain Brake").

Reactive Forces

The most common reactive forces are: kickback, pushback and pull-in.

Dangers of kickback



Kickback can result in fatal cuts.

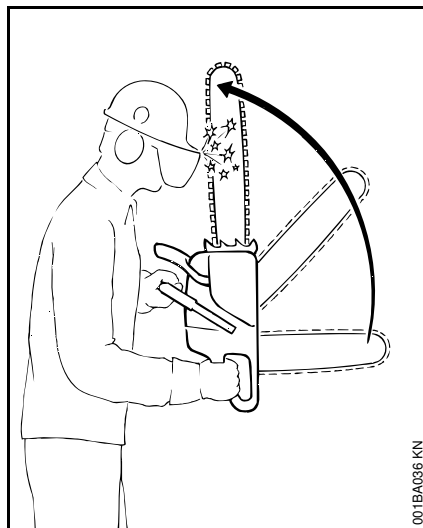

Kickback occurs when the saw is suddenly thrown up and back in an uncontrolled arc towards the operator.

Kickback occurs if, for example,

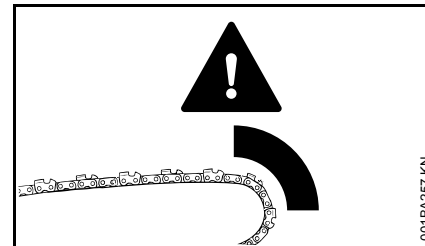

- The saw chain in the area of the upper quarter of the guide bar nose unintentionally comes into contact with wood or a solid object – e. g., unintentionally touches another limb during limbing
- The saw chain at the nose of the guide bar is briefly pinched in the cut

QuickStop chain brake:

This device reduces the risk of injury in certain situations – it cannot prevent kickback. If activated, the brake stops the saw chain within a fraction of a second – refer to chapter "Chain brake" in this Instruction Manual.

Reducing the risk of kickback

- Work cautiously and methodically
- Hold the chain saw firmly with both hands and maintain a secure grip
- Always cut at full throttle
- Be aware of the location of the guide bar nose
- Do not cut with the guide bar nose

English

- Be especially careful with small, tough limbs, undergrowth and offshoots – the saw chain may become caught in them
- Never cut several limbs at once
- Do not lean too far forward
- Do not cut above shoulder height
- Use extreme caution when re-entering a previous cut
- Do not attempt plunge cuts if you are not experienced in this cutting technique
- Be alert for shifting of the log or other forces that may cause the cut to close and pinch the chain
- Always cut with a correctly sharpened, properly tensioned saw chain – the depth gauge setting must not be too large
- Use low-kickback saw chains as well as narrow-radius guide bars

Pull-in (A)

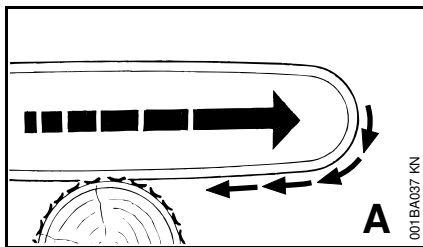

When the chain on the bottom of the bar – overbucking – is suddenly pinched, caught or encounters a foreign object in the wood, the chain saw may suddenly

be drawn forward toward the log – **to avoid this, engage the bumper spike firmly in the wood.**

Pushback (B)

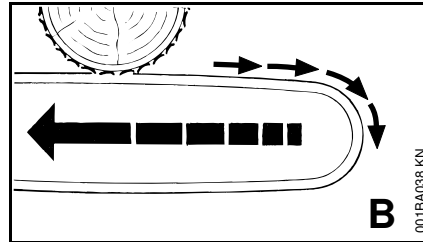

When the chain on the top of the bar – underbucking – is suddenly pinched, caught or encounters a foreign object in the wood, the chain saw may suddenly be driven straight back toward the operator – **to avoid this:**

- Do not allow the top of the guide bar to become jammed
- Do not twist the guide bar in the cut

Be very careful

- With freely hanging limbs
- With trunks that are under tension between other trees because they fell unfavourably
- When working in windbreaks

In these cases, do not use a chain saw – use a hoist, winch or dragline instead.

Pull out trunks that are lying about and have been cut free. Whenever possible, deal with them in open areas.

Dead wood (brittle, rotten or dead wood) poses a significant, highly unpredictable hazard. It is extremely difficult or even practically impossible to recognise the danger. Use aids such as winches or draglines.

When **falling close to roads, rail lines, power lines**, etc., work with particular care. If necessary, notify police, power companies or railway authorities.

Working Techniques

Only specially trained persons may perform cutting and felling operations and all other associated work (plunge cutting, limbing, etc.). To reduce the risk of accidents and injury, do not attempt felling or limbing if you are not an experienced chainsaw user.

Gasoline chain saws are more suitable than electric saws for felling and limbing. The freedom of movement necessary for this work is restricted by the connecting cord.

Your electric chain saw is unsuitable for cutting in blowdown areas and must not be used for such work.

However, if a tree is to be felled and limbed with an electric saw against this recommendation, it is essential to observe country-specific regulations on felling techniques.

Sawing

Work calmly and carefully – in daylight conditions and only when visibility is good. Do not endanger others – stay alert at all times.

It is advisable for first-time users to practice cutting logs on a sawbuck – see "Sawing thin wood".

Use the shortest possible guide bar: The chain, guide bar and chain sprocket must match each other and your saw.

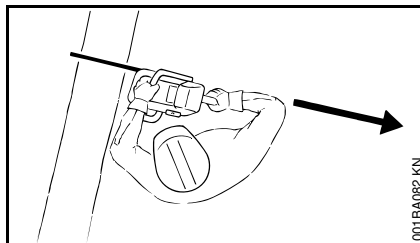

Make certain that all parts of your body are well clear of the extended **range of travel** of the saw chain.

Always pull the saw out of the cut with the saw chain running.

Use the chain saw only for sawing – not for prying or shovelling away limbs or roots.

Do not underbuck freely hanging limbs.

Be careful when cutting scrub and young trees. Thin shoots can be scooped up by the chain saw and hurled towards the user.

Be careful when cutting shattered wood – **risk of injury from splinters being caught and thrown in your direction!**

Make sure your saw does not touch any foreign materials: Stones, nails, etc. may be flung off and damage the saw chain. The chain saw may kick back unexpectedly – **risk of accident!**

If a rotating saw chain hits a stone or another hard object, there may be sparks, which under certain conditions can cause easily combustible materials to catch fire. Even dry plants and scrub are easily combustible, especially in hot, dry weather conditions. If there is a risk of fire, do not use the chain saw in the vicinity of easily combustible materials,

dry plants or scrub. Always check with the relevant forestry commission if there is a risk of fire.



On slopes, always stand above or to the side of the trunk or felled tree. Watch out for rolling trunks.

When working at heights:

- Always use a lift bucket
- Never work on a ladder or in a tree
- Never use the machine in unsteady locations
- Never cut above shoulder height
- Never use the machine with one hand

Begin cutting with the saw at full throttle and engage the bumper spike – then saw.

Never use the chain saw without the bumper spike, the saw may pull you forward suddenly. Always engage the bumper spike securely.

At the end of the cut, the chain saw is no longer supported by the cutting attachment in the cut. The chain saw's weight must be borne by the user – **risk of loss of control!**

Sawing thin wood:

- Use a sturdy, stable fixture – sawhorse
- Do not hold the wood in place with your foot
- Other persons must neither be allowed to hold the wood nor help in any other way

Limbing:

- Use a low-kickback saw chain
- Support the chain saw as much as possible
- Do not stand on the trunk when limbing
- Do not cut with the guide bar nose
- Watch out for limbs that are under tension
- Never cut several limbs at once

Lying or standing logs under tension:

Always make the cuts in the correct order (first compression side (1), then tension side (2)), otherwise the cutting attachment may stick in the cut or kick back – **risk of injury!**

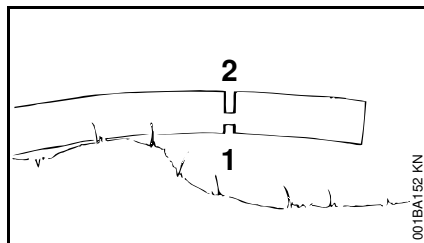
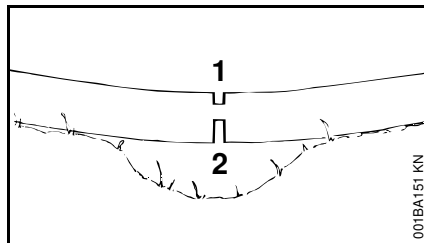

- Make relieving cut in the compression side (1)
- Make bucking cut in the tension side (2)

If the bucking cut is made from the bottom upwards (underbuck) – **risk of pushback!**



Lying logs must not touch the ground at the point where the cut is made – otherwise the chain will be damaged.

Ripping:

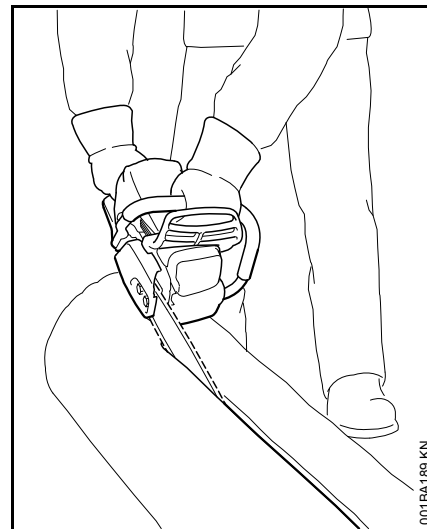

Sawing technique without use of the spiked bumper – risk of pull-in – position the guide bar at as shallow an angle as possible – be especially careful – increased **risk of kickback!**

Preparing for felling

Only persons who are engaged in felling may be present in the felling area.

Make certain that no one is endangered by the falling tree – engine noise can drown out shouting.

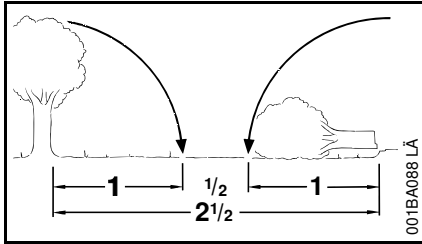

The distance to the next worksite must be at least 2 1/2 tree lengths.

Specify the direction of fall and escape paths

Select a gap in the timber stand into which the tree can be felled.

Pay special attention to the following points:

- The natural inclination of the tree
- Unusually heavy limb structure, asymmetrical growth, damage to tree
- Wind direction and speed – do not fell trees in high winds
- Direction of slope
- Neighboring trees
- Snow load
- Take the general condition of the tree into account – be especially careful with trunk damage or deadwood (brittle, rotten or dead wood)

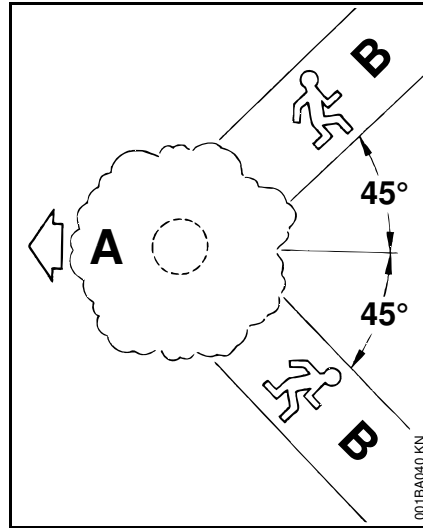

A Direction of fall

B Escape path (escape routes)

- Establish escape paths for each worker – approx. 45° diagonally opposite to the direction of fall
- Clear escape paths, eliminate obstacles
- Put down tools and equipment at a safe distance – but not on the escape paths
- When felling, stand only to the side of the falling trunk and only move back laterally onto the escape path
- Plan escape paths on slopes parallel to the slope
- When getting out of the way, watch out for falling branches and the crown area

Preparing the work area at the trunk

- Clear the work area at the trunk of branches, brush and other obstacles – secure footing for all workers
- Carefully clear the base of the trunk (e.g., with an axe) – sand, stones and other foreign objects will blunt the saw chain

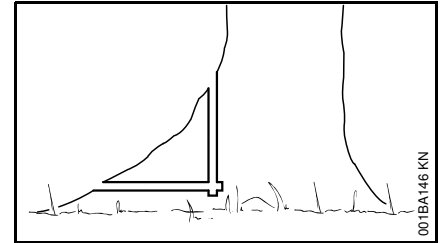

- Remove large buttresses: remove the largest buttress first – saw first vertically, then horizontally – only if the tree is in sound condition

Felling notch

Preparing the felling notch

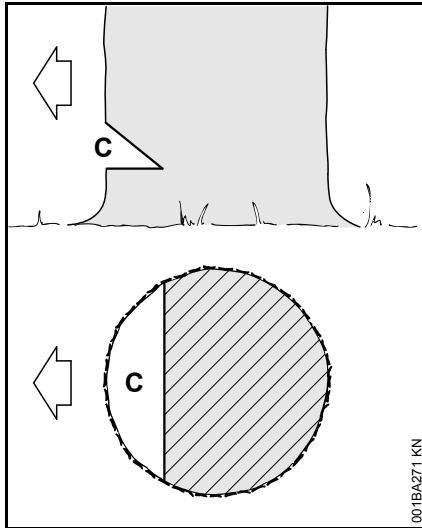

The felling notch (C) determines the direction of fall.

Important:

- Make a felling notch at right angle to direction of fall
- Saw as close to the ground as possible
- Cut to a depth of approx. 1/5 to 1/3 of the diameter of the trunk

Specify the direction of fall – without the gunning sight on the shroud and fan housing

If the chain saw is designed without the gunning sight on the shroud and fan housing, the direction of fall can be determined or controlled using a meter stick:

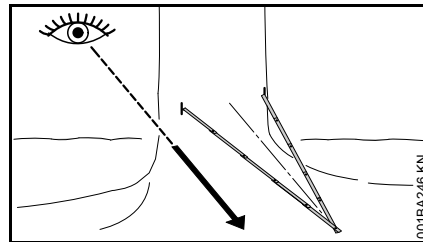

- Snap the meter stick in the middle and create an isosceles triangle
- Position both ends of the meter stick in the front trunk area (1/5 to max. 1/3 of the trunk diameter) – align the tip of the meter stick in the defined direction of fall
- Mark the trunk at both ends of the meter stick to limit the felling notch

Making a felling notch

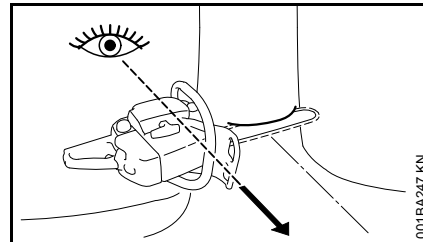

When making a felling notch, align the machine so that the notch lies at a right angle to the direction of fall.

During the procedure various sequences are permitted for making a felling notch with a bottom (horizontal) cut and top (angled) cut – comply with national legislation regarding felling technique.

- Make the bottom cut (horizontal cut) – until the guide bar reaches both markings
- Make the top (angled) cut approx. 45° - 60° to the bottom cut

Checking the direction of fall

The bottom cut and top cut must meet in a continuous straight sink chord.

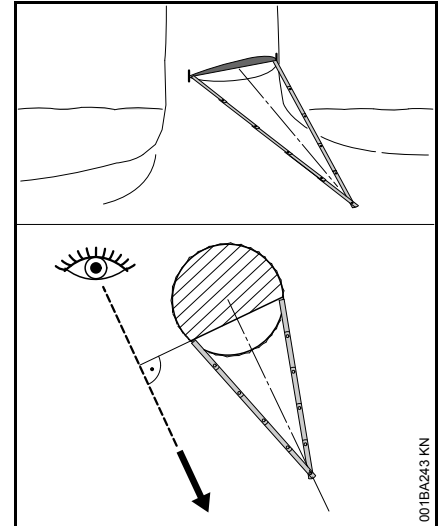

- Position the meter stick at the pivot point of the sink chord – the tip of the meter stick must point in the direction of the specified direction of fall – where necessary, correct the direction of fall by cutting the felling notch accordingly

Sapwood cuts

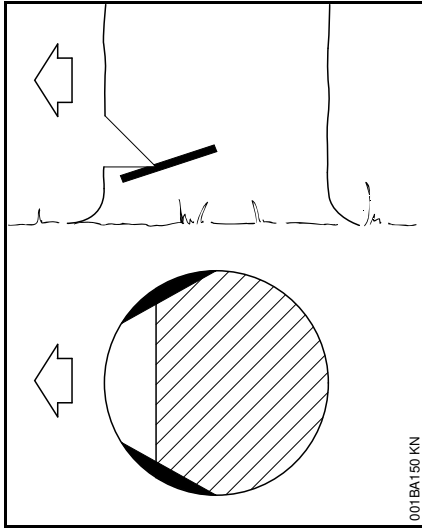

With long-fibered wood, sapwood cuts prevent the sapwood from splintering when felling the trunk – saw both sides of the trunk at the level of the felling notch base to approx. 1/10 of the diameter of the trunk – with thicker trunks, not more than the width of the guide bar.

Do not use sapwood cuts on diseased trees.

Backcutting principles

Basic dimensions

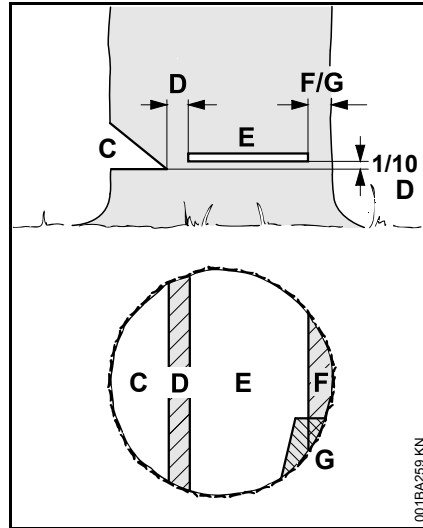

The **felling notch** (C) determines the direction of fall.

The **hinge** (D) functions like a real hinge to guide the tree to the ground.

- Width of hinge: approx. 1/10 of the trunk diameter
- Never saw through the hinge while felling – otherwise the tree will fall in a direction other than the one planned – **risk of accident!**
- With rotten trunks, leave a wider hinge

The tree is felled with the **backcut** (E).

- Exactly horizontal
- 1/10 (min. 3 cm) of the width of the hinge (D) across the bottom of the felling notch (C)

The **holding wood** (F) or **safety strip** (G) supports the tree and secures it against premature falling.

- Width of strip: approx. 1/10 to 1/5 of the trunk diameter
- Do not cut into the strip during the backcut
- With rotten trunks, leave a wider strip

Plunge cutting

- For relieving cuts during bucking
- For wood carving

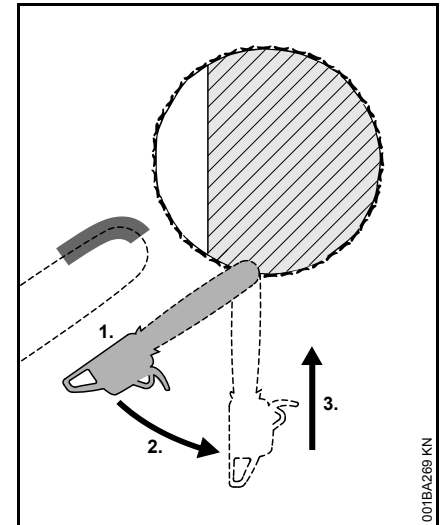

- Use a low kickback chain and be especially cautious
1. Begin the cut by applying the lower portion of the guide bar tip – do not use the upper portion – **risk of kickback!** Cut at full strength until the depth of the kerf is twice the width of the guide bar

2. Swing the machine slowly into the plunge cutting position – **risk of kickback and pushback!**
3. Make the plunge cut very carefully – **danger of pushback!**

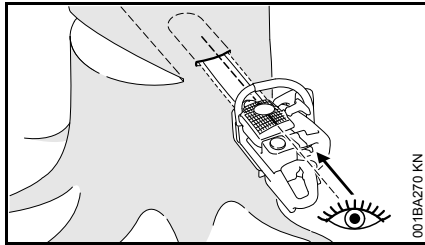

Where possible, use a plunge blade. The plunge blade and the upper/lower side of the guide bar are parallel.

During plunge cutting, the plunge bar helps to keep the hinge parallel in form, i.e. the same thickness at all points. To do this, guide the plunge bar parallel to the sink chord.

Felling wedges

Insert the felling wedge as soon as possible, i.e. as soon as saw control cannot be hindered. Position the felling wedge in the backcut and drive in with suitable tools.

Only use aluminium or plastic wedges – do not use steel wedges. Steel wedges can seriously damage the saw chain and cause dangerous kickback.

Select suitable felling wedges dependent on the trunk diameter and the width of the kerf (analogue to backcut (E)).

Contact the STIHL servicing dealer for the selection of the felling wedge (suitable length, width and height).

Select the appropriate backcut

The selection of the appropriate backcut is dependent on the same tree characteristics that must be noted when determining the direction of fall and the escape paths.

There are various different features of these characteristics. This Instruction Manual will only describe the two most commonly occurring variants:

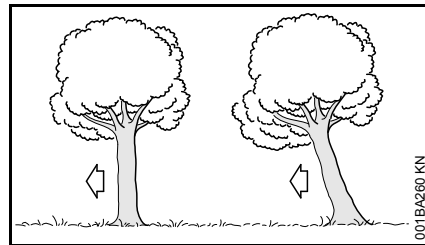

Left: Normal tree – vertically upright tree with uniform crown

Right: Leaner tree - Crown pointing in direction of fall

Back cut with safety strip (normal tree)

(A) Thin trunks

Implement this backcut when the trunk diameter is smaller than the cutting length of the machine.

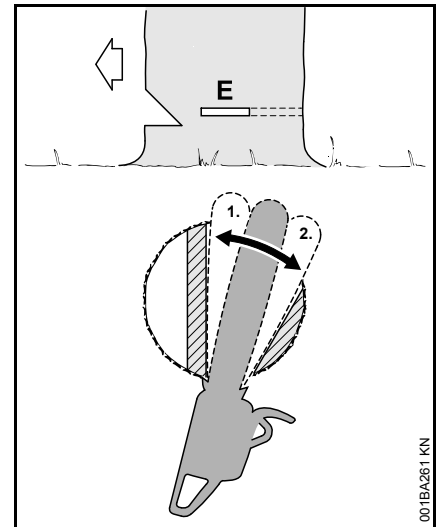

Give a warning cry of "timber!" before making the backcut.

- Plunge cut the backcut (E) – plunge the guide bar fully in
- Engage the bumper spike behind the hinge and use this as the rotation point – reposition the machine as little as possible
- Make the backcut up to the hinge (1)
 - Do not cut into the hinge
- Make the backcut up to the safety strip (2)
 - Do not cut into the safety strip

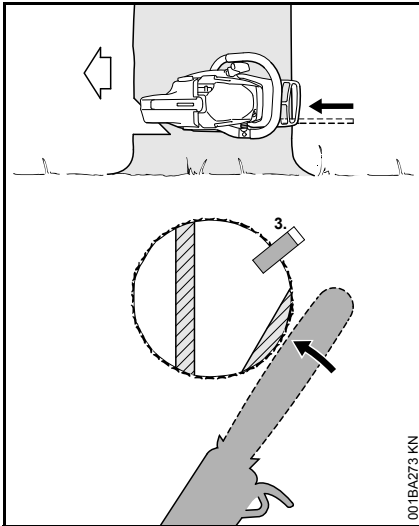

- Set the felling wedge (3)
- Immediately before felling the tree, give out a second warning cry of "timber!".
- Cut through the safety strip, horizontal level with the backcut, with arms fully extended

B) Thick trunks

Implement this backcut when the trunk diameter is greater than the cutting length of the machine.

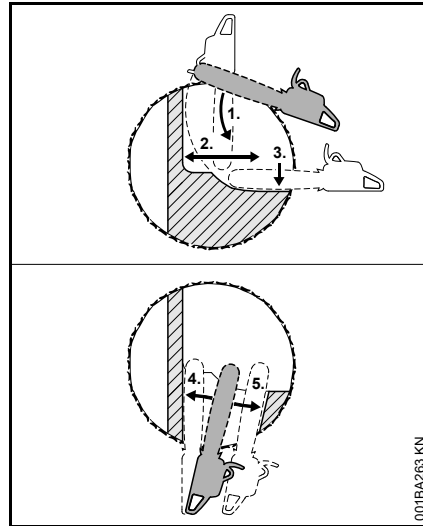

Give a warning cry of "timber!" before making the backcut.

- Engage the bumper spike at the height of the backcut and use this as the rotation point – reposition the machine as little as possible
- Tip of the guide bar must penetrate the wood before the hinge (1) – guide machine absolutely horizontally and swivel as widely as possible
- Make the backcut up to the hinge (2)
 - Do not cut into the hinge
- Make the backcut up to the safety strip (3)
 - Do not cut into the safety strip

The backcut must be continued on the opposite side of the trunk.

Ensure that the second cut is at the same level as the first cut.

- Plunge cut the backcut
- Make the backcut up to the hinge (4)
 - Do not cut into the hinge
- Make the backcut up to the safety strip (5)
 - Do not cut into the safety strip

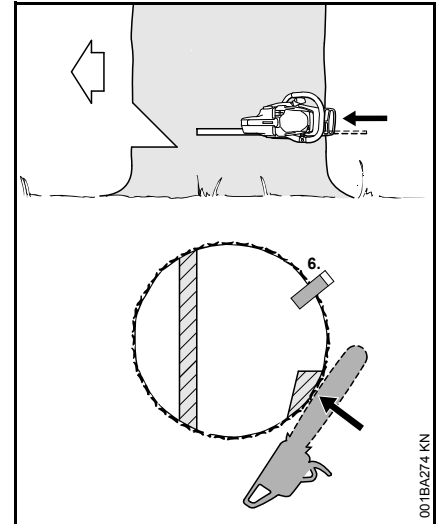

- Set the felling wedge (6)
- Immediately before felling the tree, give out a second warning cry of "timber!".
- Cut through the safety strip, horizontal level with the backcut, with arms fully extended

Backcut with holding wood (leaner tree)

A) Thin trunks

Implement this backcut when the trunk diameter is smaller than the cutting length of the machine.

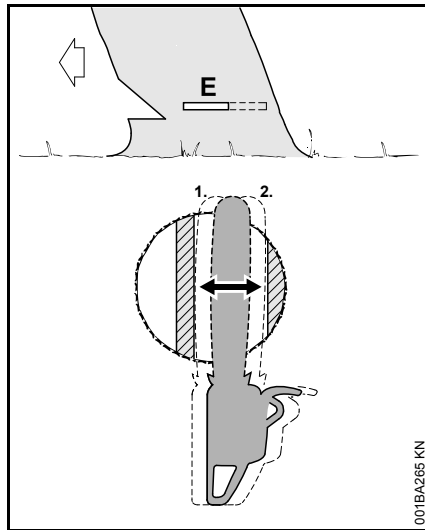

- Plunge cut the guide bar into the trunk until it exits on the other side
- Make the backcut (E) towards the hinge (1)
 - Exactly horizontal
 - Do not cut into the hinge
- Make the backcut towards the holding wood (2)
 - Exactly horizontal
 - Do not cut into the holding wood

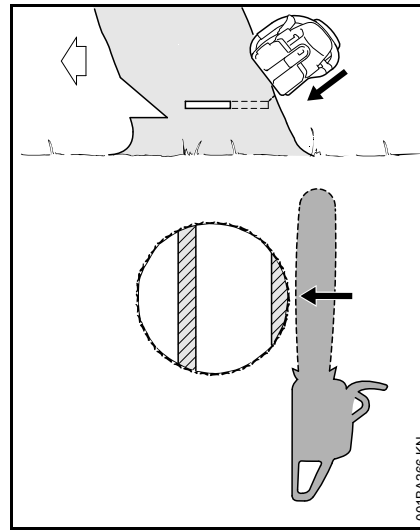

Immediately before felling the tree, give out a second warning cry of "timber!".

- Cut through the holding wood at an angle from above with arms fully extended

B) Thick trunks

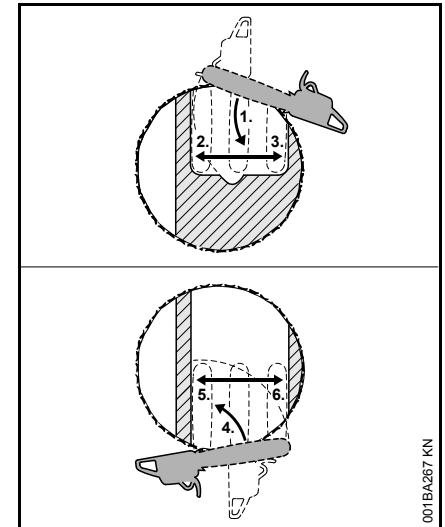

Implement this backcut when the trunk diameter is greater than the cutting length of the machine.

- Engage the bumper spike behind the holding wood and use this as the rotation point – reposition the chain saw as little as possible
- Tip of the guide bar must penetrate the wood before the hinge (1) – guide the chain saw absolutely horizontally and swivel as widely as possible
 - Do not cut into the holding wood and hinge
- Make the backcut up to the hinge (2)
 - Do not cut into the hinge
- Make the backcut up to the holding wood (3)
 - Do not cut into the holding wood

The backcut must be continued on the opposite side of the trunk.

Ensure that the second cut is at the same level as the first cut.

- Engage the bumper spike behind the hinge and use this as the rotation point – reposition the machine as little as possible
- Tip of the guide bar must penetrate the wood before the holding wood (4) – guide machine absolutely horizontally and swivel as widely as possible
- Make the backcut up to the hinge (5)
 - Do not cut into the hinge
- Make the backcut up to the holding wood (6)
 - Do not cut into the holding wood

- Cut through the holding wood at an angle from above with arms fully extended

Packing List

Remove the machine from the box and check that you have all the following items:

- Electric chainsaw
- Guide bar
- Saw chain
- Chain scabbard
- Instruction manual

Only models without quick chain tensioner

- Combination wrench

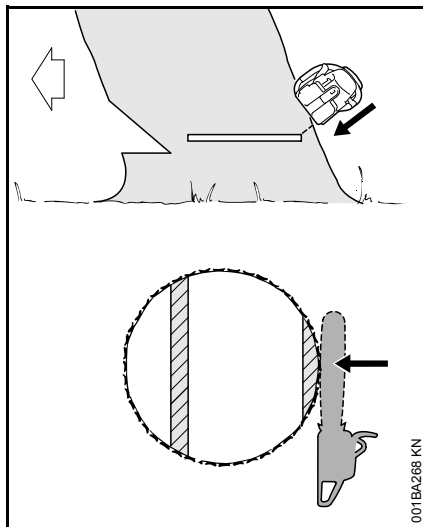

Immediately before felling the tree, give out a second warning cry of "timber!".

Cutting Attachment

A cutting attachment consists of the saw chain, guide bar and chain sprocket.

The cutting attachment that comes standard is designed to exactly match the chain saw.

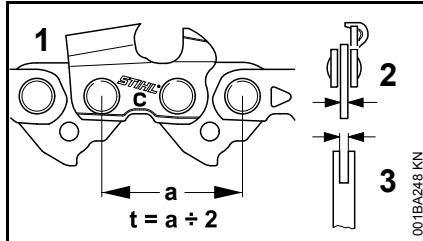

- The pitch (t) of the saw chain (1), chain sprocket and the nose sprocket of the Rollomatic guide bar must match.
- The drive link gauge (2) of the saw chain (1) must match the groove width of the guide bar (3).

If non-matching components are used, the cutting attachment may be damaged beyond repair after a short period of operation.

Chain Scabbard

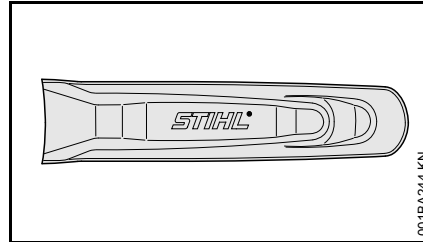

Your saw comes standard with a chain scabbard that matches the cutting attachment.

If guide bars of different lengths are mounted to the saw, always use a chain scabbard of the correct length which covers the complete guide bar.

The length of the matching guide bars is marked on the side of the chain scabbard.

Mounting the Bar and Chain (side chain tensioner)



WARNING

Do not connect the power tool to the wall outlet yet.

Removing the chain sprocket cover

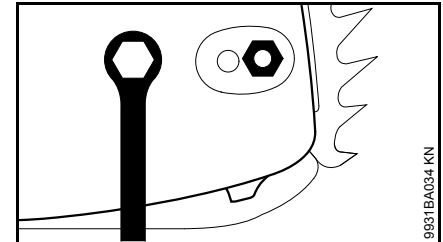

- Unscrew the nut and remove the chain sprocket cover.

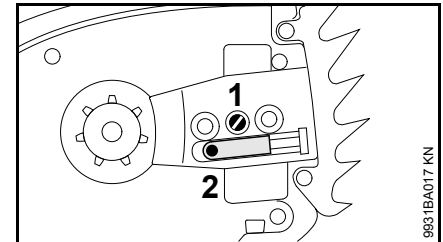

- Turn the tensioning screw (1) counterclockwise until the tensiometer slide (2) butts against the left end of the housing slot.

Disengage the chain brake.

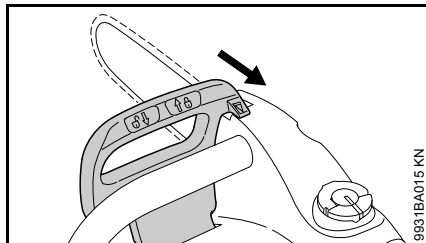

- Pull the hand guard towards the front handle until there is an audible click – the chain brake is disengaged.

Fitting the chain

! WARNING

Wear work gloves to protect your hands from the sharp cutters.

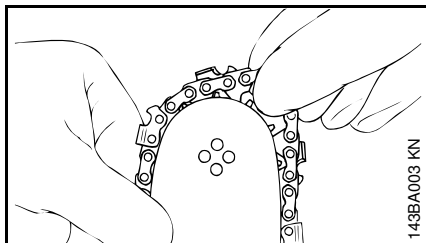

- Fit the chain – start at the bar nose.

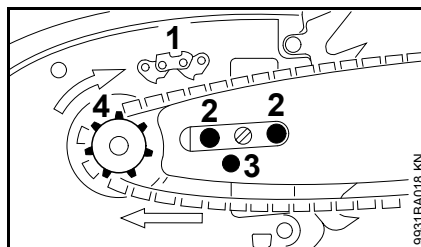

- Turn the guide bar so that the chain is positioned as shown in the pictogram (1) – the arrows show the chain's direction of rotation.
- Fit the guide bar over the studs (2) and engage the tensioner slide in the hole (3) – place the chain over the sprocket (4) at the same time.

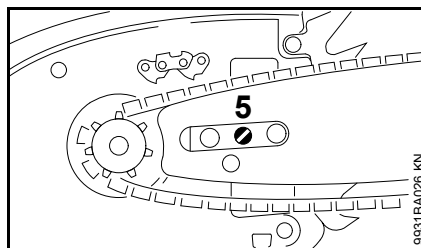

- Turn the tensioning screw (5) clockwise until there is very little chain sag on the underside of the bar – and the drive link tangs are engaged in the bar groove.
- Refit the sprocket cover and tighten the nut only moderately by hand – finally tighten the nut only after tensioning the saw chain.
- Go to chapter on "Tensioning the Saw Chain"

Mounting the Bar and Chain (quick chain tensioner)

! WARNING

Do not connect the power tool to the wall outlet yet.

Removing the chain sprocket cover

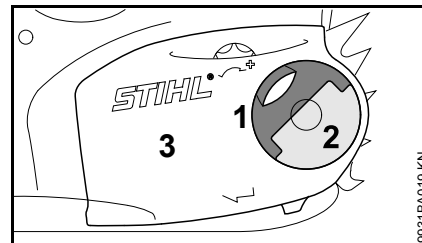

- Pull the hinged handle (1) out until it engages in the upright position.
- Turn the wingnut (2) counterclockwise until it hangs loose in the sprocket cover (3).
- Remove the chain sprocket cover (3).

Fitting the tensioning gear

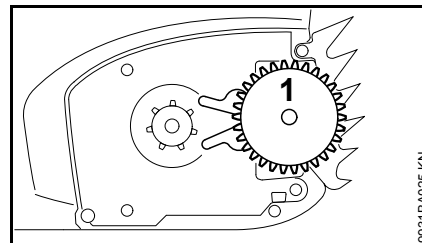

- Remove the tensioning gear (1) and turn it over.

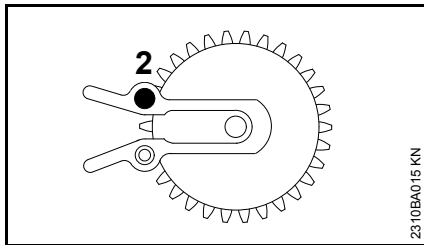

2310BA015 KN

- Take out the screw (2).

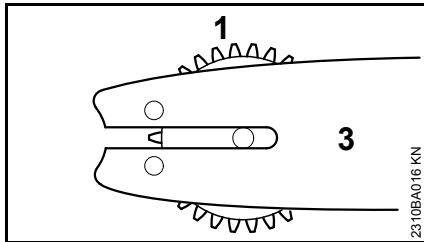

2310BA016 KN

- Line up the tensioning gear (1) and guide bar (3).

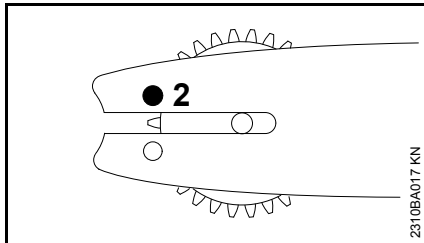

2310BA017 KN

- Insert the screw (2) and tighten it down firmly.

Disengage the chain brake.

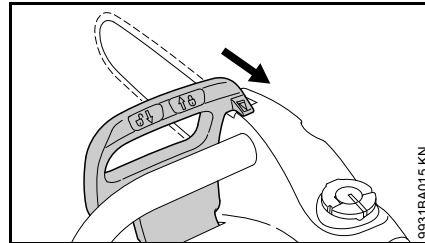

9831BA015 KN

- Pull the hand guard towards the front handle until there is an audible click – the chain brake is disengaged.

Fitting the chain



WARNING

Wear work gloves to protect your hands from the sharp cutters.

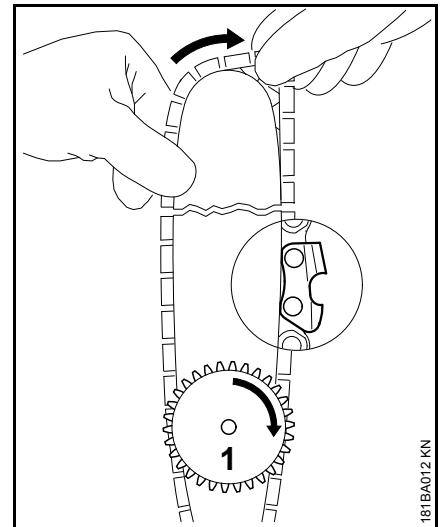

181BA012 KN

- Fit the chain – start at the bar nose. Pay attention to the position of the tensioning gear and the cutting edges.
- Turn the tensioning gear (1) clockwise as far as stop.
- Turn the guide bar so that the tensioning gear is facing you.

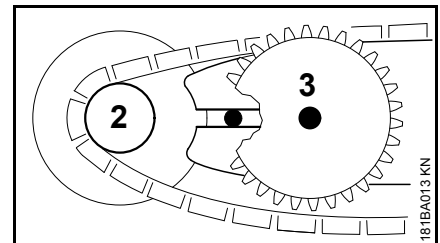

181BA013 KN

- Fit the chain over the sprocket (2).
- Push the guide bar over the bar stud (3), the head of the rear bar stud must engage the slot.

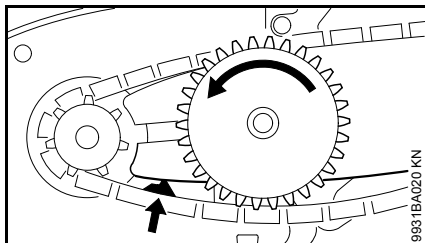

- Make sure the drive link tangs engage the bar groove (arrow) and then rotate the tensioning gear counterclockwise as far as stop.

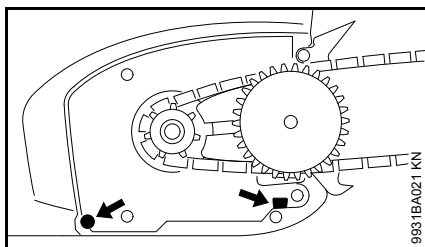

- Place the chain sprocket cover in position and engage the guide lugs in the recesses in the handle housing.

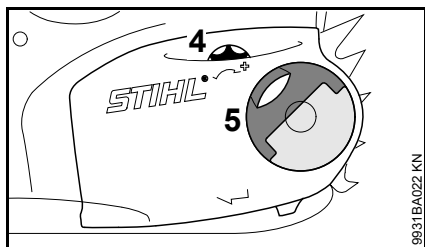

When fitting the chain sprocket cover, check that the teeth of the tensioning gear and adjusting wheel mesh properly.

- If necessary, turn the adjusting wheel (4) slightly until the sprocket cover can be pushed flush against the handle housing.
- Pull the hinged handle (5) out until it engages in the upright position.
- Fit the wingnut and tighten it moderately – finally tighten the wingnut by hand only after tensioning the saw chain.
- Go to chapter on "Tensioning the Saw Chain"

Tensioning the Saw Chain (side chain tensioner)

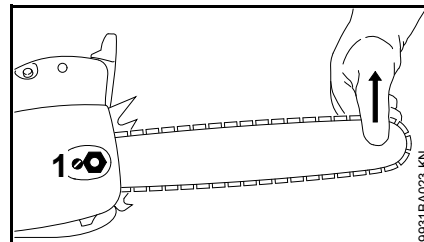

Retensioning during cutting work:

- Disconnect the plug from the wall outlet.
- Loosen the nut.
- Hold the bar nose up.
- Use a screwdriver to turn the tensioning screw (1) clockwise until the chain fits snugly against the underside of the bar.
- While still holding the bar nose up, tighten down the nut firmly.
- Go to "Checking Chain Tension".

A new chain has to be retensioned more often than one that has been in use for some time.

- Check chain tension frequently – see chapter on "Operating Instructions".

Tensioning the Saw Chain (quick chain tensioner)

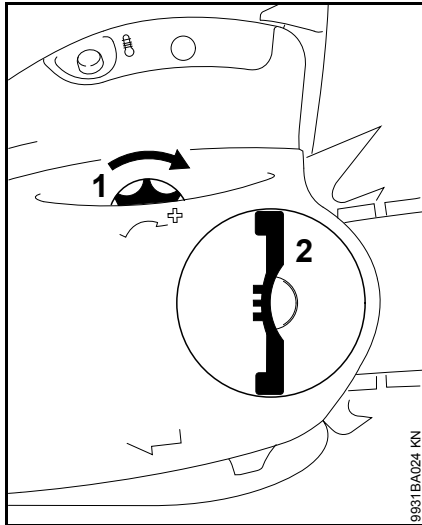

Retensioning during cutting work:

- Disconnect the plug from the wall outlet.
- Pull out the hinged grip and loosen the wingnut.
- Turn the adjusting wheel (1) clockwise as far as stop.
- Tighten down the wingnut (2) firmly by hand.
- Fold down the hinged grip.
- Go to "Checking Chain Tension".

A new chain has to be retensioned more often than one that has been in use for some time.

- Check chain tension frequently – see chapter on "Operating Instructions".

Checking Chain Tension

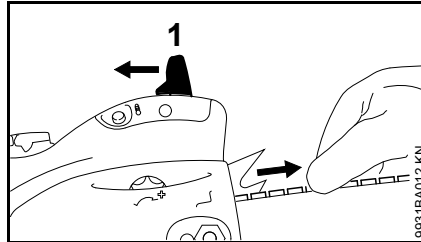

- Disconnect the plug from the wall outlet.
- Wear work gloves to protect your hands.
- Disengage the chain brake: Pull the hand guard (1) against the front handle and hold it there – the chain brake and coasting brake are disengaged in this position.
- The chain must fit snugly against the underside of the bar and it must still be possible to pull the chain along the bar by hand.
- If necessary, retension the chain.

A new chain has to be retensioned more often than one that has been in use for some time.

- Check chain tension frequently – see chapter on "Operating Instructions".

Chain Lubricant

For automatic and reliable lubrication of the chain and guide bar – use only an environmentally compatible quality chain and bar lubricant. Rapidly biodegradable STIHL BioPlus is recommended.



NOTICE

Biological chain oil must be resistant to aging (e.g. STIHL BioPlus), since it will otherwise quickly turn to resin. This results in hard deposits that are difficult to remove, especially in the area of the chain drive and chain. It may even cause the oil pump to seize.

The service life of the chain and guide bar depends on the quality of the lubricant. It is therefore essential to use only a specially formulated chain lubricant.



WARNING

Do not use waste oil. Renewed contact with waste oil can cause skin cancer. Moreover, waste oil is environmentally harmful.



NOTICE

Waste oil does not have the necessary lubricating properties and is unsuitable for chain lubrication.

Filling Chain Oil Tank



Preparations

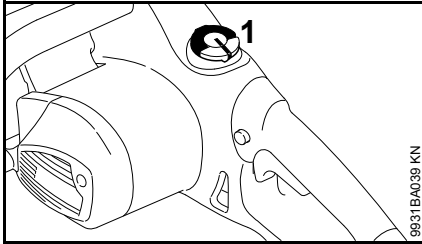

- Thoroughly clean the oil filler cap (1) and the area around it to ensure that no dirt falls into the tank.
- Position the machine so that the filler cap faces up.

Opening the filler cap

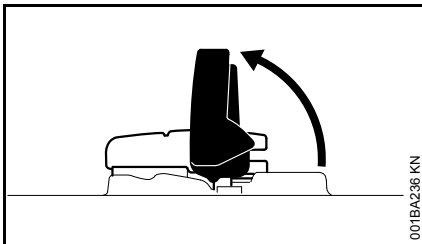

- Raise the grip until it is upright.

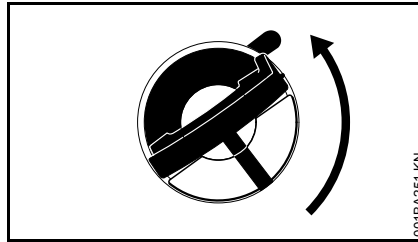

- Turn the cap counterclockwise (about a quarter turn).

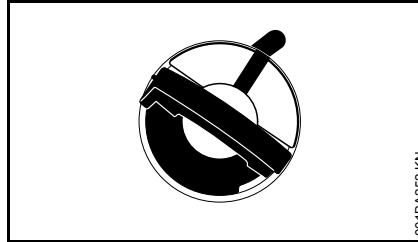

Marks on filler cap and oil tank must line up.

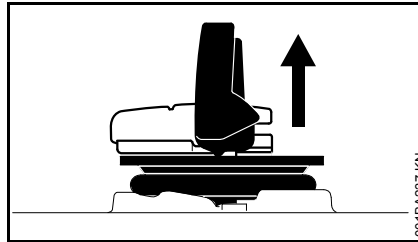

- Remove the cap.

Filling up with chain oil

Take care not to spill chain oil while refilling and do not overfill the tank.

STIHL recommends you use the STIHL filler nozzle for chain oil (special accessory).

- Filling up with chain oil

Closing the filler cap



Grip must be vertical:

- Fit the cap – marks on filler cap and oil tank must line up.
- Press the cap down as far as stop.

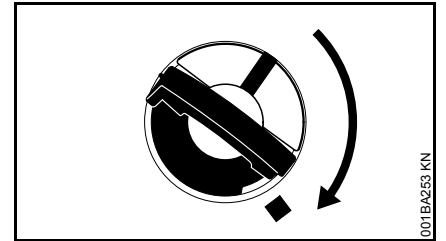

- While holding the cap depressed, turn it clockwise until it engages in position.

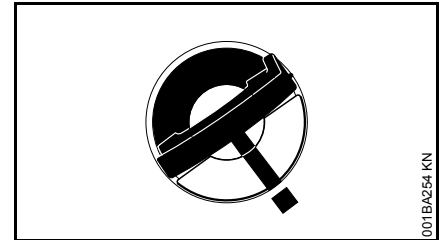

The marks on the filler cap and oil tank are then in alignment.

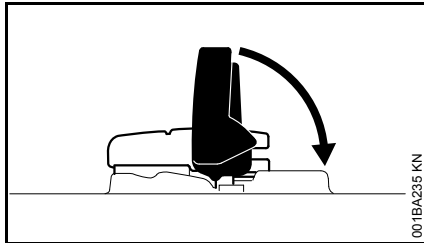

001BA235 KN

- Fold the grip down.

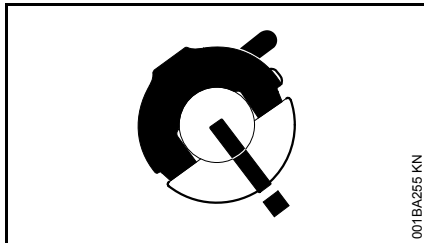

001BA235 KN

Filler cap is locked.

If the filler cap cannot be locked in the oil tank opening

Bottom of cap is twisted in relation to top.

- Remove the cap from the oil tank and check it from above.

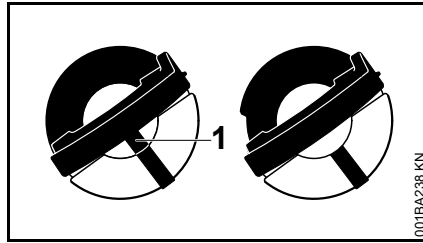

001BA238 KN

Left: Bottom of cap is twisted – inner mark (1) in line with outer mark.

Right: Bottom of cap in correct position – inner mark is under the grip. It is not in line with the outer mark.

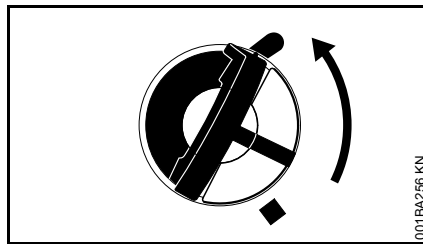

001BA256 KN

- Place the cap on the opening and rotate it counterclockwise until it engages the filler neck.
- Continue rotating the cap counterclockwise (about a quarter turn) – this causes the bottom of the cap to be turned to the correct position.
- Turn the cap clockwise and lock it in position – see section on "Closing the filler cap".

Checking oil level

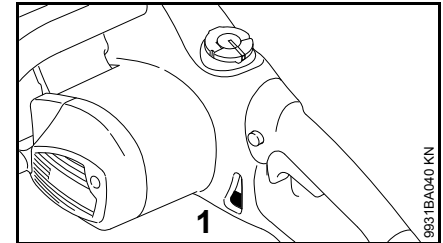

9931BA040 KN

- Check the oil level regularly during operation.
- Top up the oil tank when the oil level reaches the "min" mark (1) or earlier.

If the oil level in the tank does not go down, the reason may be a fault in the oil supply system: Check chain lubrication, clean the oilways, contact your dealer for assistance if necessary STIHL recommends that you have servicing and repair work carried out exclusively by an authorized STIHL servicing dealer.

Checking Chain Lubrication

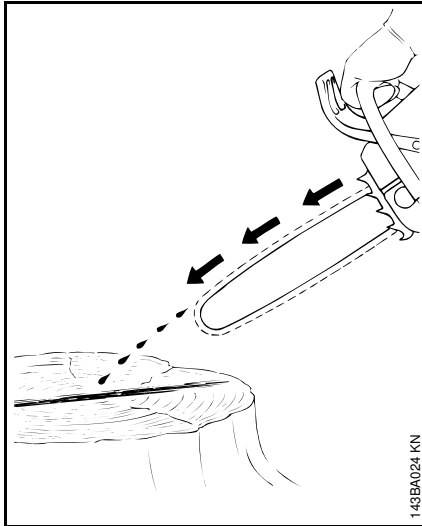

The saw chain must always throw off a small amount of oil.

NOTICE

Never operate your saw without chain lubrication. If the chain runs dry, the whole cutting attachment will be irretrievably damaged within a very short time. Always check chain lubrication and the oil level in the tank before starting work.

Every new chain has to be broken in for about 2 to 3 minutes.

After breaking in the chain, check chain tension and adjust if necessary – see "Checking Chain Tension".

Coasting Brake

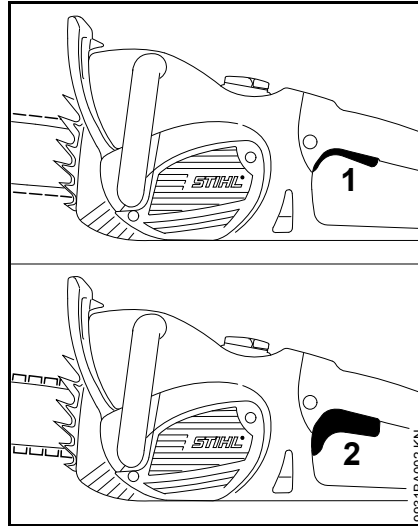

The coasting brake brings the running chain to a standstill when you fully let go of the trigger switch.

- 1 Coasting brake off
- 2 Coasting brake activated

Chain Brake

Locking the chain

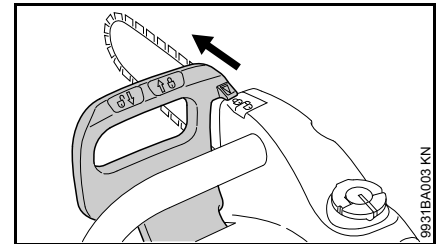

- in an emergency

The chain brake is activated by pushing the hand guard toward the bar nose with your left hand (position ) – or by inertia in certain kickback situations: The chain is stopped and locked.

Disengage the chain brake.

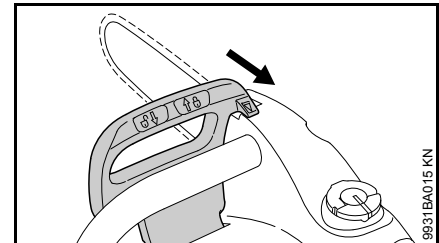

- Pull the hand guard back toward the front handle (position )



The chain brake is also activated by the inertia of the front hand guard if the kickback force of the saw is high enough: The hand guard is accelerated

toward the bar nose – even if your left hand is not behind the hand guard, e.g. during a horizontal cut.

The chain brake will operate only if the hand guard has not been modified in any way.

Checking operation of the chain brake

Before starting work:

- Move hand guard to position  – chain brake is disengaged.
- Switch on the saw.
- Push the hand guard towards the bar nose (position .

The chain brake is working properly if the saw chain comes to a standstill within a few fractions of a second.

The hand guard must be free from dirt and move freely.

Chain brake maintenance

The chain brake is subject to normal wear. It is necessary to have it serviced and maintained regularly by trained personnel. STIHL recommends that you have servicing and repair work carried out exclusively by an authorized STIHL servicing dealer. Maintain the following servicing intervals:

Full-time usage:	every 3 months
Part-time usage:	every 6 months
Occasional usage:	every 12 months

Connecting to Power Supply

The voltage and frequency of the machine (see rating plate) and the voltage and frequency of your power supply must be the same.

The mains connection must be protected by a fuse with a minimum rating in accordance with the specifications – see "Specifications".

The unit must be connected to the power supply via a ground-fault circuit breaker, which interrupts the power supply to the unit if the leakage current to ground exceeds 30 mA.

The mains connection must comply with IEC 60364-1 and country-specific regulations.

When the machine is switched on, voltage fluctuations that occur under unfavorable mains conditions (high mains impedance) may affect other connected loads. Contact your local electric utility for information on the mains impedance. Connect your power tool only to a suitable mains supply system – for maximum permissible mains impedance see "Specifications".

Extension cord

The design of the extension cord must at least fulfill the same features as the connecting cord on the machine. Observe the design marking (type designation) on the connecting cord.

The cores in the cord must have the following minimum cross-section depending on the mains voltage and cord length.

Cord length	Minimum cross-section
220 V – 240 V:	
Up to 20 m	1.5 mm ²
20 m to 50 m	2.5 mm ²

100 V – 127 V:	
Up to 10 m	AWG 14 / 2.0 mm ²
10 m to 30 m	AWG 12 / 3.5 mm ²

Connecting to Wall Outlet

- Connect the power tool's plug or the extension cord's plug to a properly installed wall outlet.

Switching On

- Make sure you have a secure and balanced footing.
- Check that bystanders are well clear of the general work area of the power tool.
- Hold the power tool firmly with both hands on the handles.
- Check that the saw chain is not touching the wood or any other object.

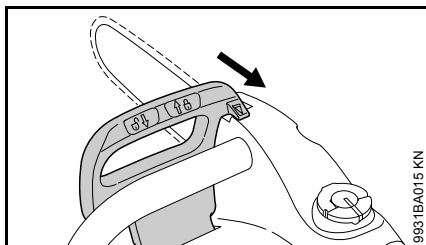

- Pull the hand guard towards the front handle until there is an audible click and it is in position  – the chain brake is disengaged.

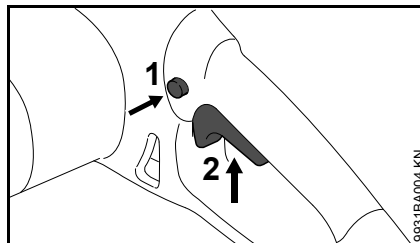

- Depress the trigger switch lockout (1) with your thumb.
- Squeeze the trigger switch (2) with your index finger.
- Start the cut with the chain running.

The motor runs only if the hand guard is on  and the trigger switch lockout (1) and trigger switch (2) are operated simultaneously.

Switching Off

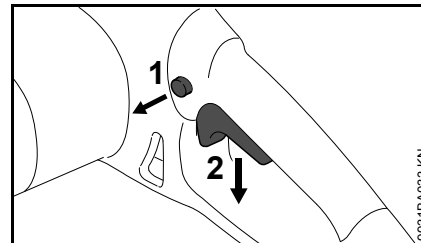



- Release the trigger switch (2) so that it can return to the off position. It is locked in this position by the trigger switch lockout (1).

The coasting brake brings the chain to a standstill.

WARNING

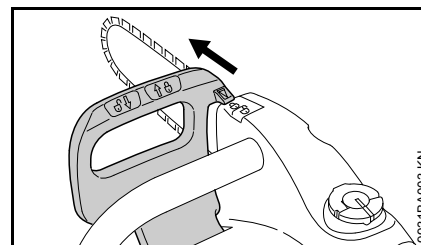
The coasting brake operates immediately only if the trigger switch is fully released. If you release the trigger switch slowly or only partly, the saw chain will continue to run for several seconds.



- Move hand guard to  – the chain is locked.

During longer work breaks – disconnect the plug from the wall outlet.

When the machine is not in use, store it in such a way that it does not endanger others.

Secure it against unauthorized use.

Overload Cutout

The overload cutout interrupts the power supply to the saw in the case of mechanical overload due to, e.g.

- excessive feed force
- "lugging down" the motor
- pinching the saw chain in the cut

If the overload cutout has interrupted the power supply:

- Pull the guide bar out of the cut.
- If necessary, disengage the chain brake – see "Chain Brake".

MSE 170 C, MSE 190 C, MSE 210 C

- Wait for the overload cutout to cool down.

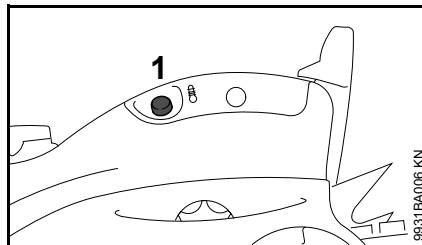

- Depress the reset button (1) as far as stop – if the motor does not run when you switch on, the overload cutout has not yet cooled down sufficiently – wait a while and then depress the reset button again as far as stop.

When the motor restarts:

- Run the motor off-load for about 15 seconds. This cools the motor and helps prevent the overload cutout from tripping again.

MSE 230 C

The MSE 230 C is equipped with an electronic overload cutout to monitor motor temperature and power consumption.

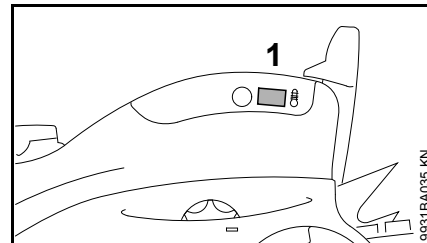

- If the indicator lamp (1) stays on for longer than 2 seconds in an overload situation, the power supply is interrupted and the saw is switched off automatically – release the trigger switch, then restart the saw.
- If the saw then restarts at a reduced RPM, it is overheated and switches off automatically after about 10 seconds – release the trigger switch, allow the saw to cool down for about one minute, then restart. If the saw again restarts at a reduced RPM, it has not cooled down sufficiently – allow it to cool down for a long as necessary until it restarts at normal RPM.

The indicator lamp glows only as long as the trigger switch is operated.

The indicator lamp flashes briefly to confirm it is functioning every time the motor is switched on.

Operating Instructions

During operation

- Check level in chain oil tank.
- Top up with chain oil when the "min" mark is reached, or earlier – see "Filling the Chain Oil Tank".

Check chain tension frequently

A new chain has to be retensioned more often than one that has been in use for some time.

Chain cold

Tension is correct when the chain fits snugly against the underside of the bar and can still be pulled along the bar by hand. Retension if necessary – see "Tensioning the Saw Chain".

Chain at operating temperature

The chain stretches and begins to sag. The drive links must not come out of the bar groove – the chain may otherwise jump off the bar. Retension the chain – see "Tensioning the Saw Chain".



NOTICE

The chain contracts as it cools down. If it is not slackened off, it can damage the drive shaft and bearings.

After finishing work

- Disconnect the plug from the wall outlet.
- Slacken off the chain if you have retensioned it at operating temperature during cutting work.



NOTICE

Always slacken off the chain after finishing work. The chain contracts as it cools down. If it is not slackened off, it can damage the drive shaft and bearings.

Storing for a long period

See chapter on "Storing the Machine"

Taking Care of the Guide Bar

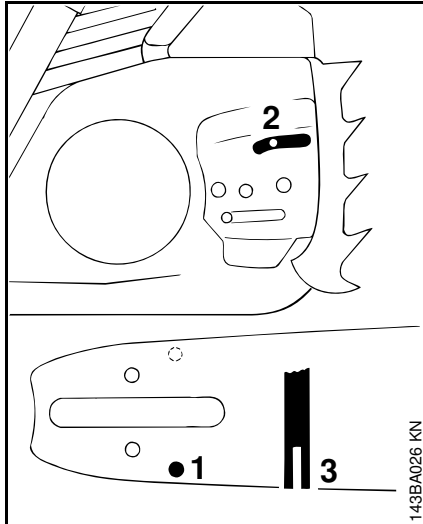

- Flip the bar – after each sharpening and each time the chain is changed – to avoid uneven wear, especially at the sprocket nose and on the bottom
- Periodically clean the oil inlet hole (1), oil outlet channel (2) and bar groove (3)
- Measure groove depth – using the measuring tool on the file gauge (special accessory) – in the area with the greatest wear

Chain type	Chain pitch	Minimum groove depth
Picco	1/4" P	4.0 mm
Rapid	1/4"	4.0 mm

Picco	3/8" P	5.0 mm
Rapid	3/8"; 0.325"	6.0 mm
Rapid	0.404"	7.0 mm

If the groove is not at least this deep:

- Replace guide bar

Otherwise the drive links will grind against the base of the groove – the bottoms of the cutters and the tie straps will not lie against the bar.

Motor Cooling

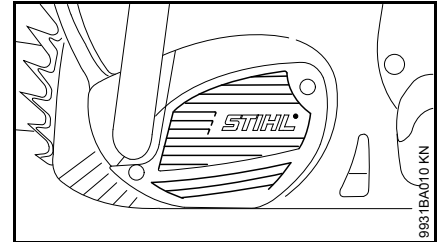

- Use a dry brush or similar tool to clean the cooling slots at regular intervals – see "Maintenance Chart".

Storing the Machine

For periods of 3 months or longer

- Disconnect the plug from the wall outlet.
- Remove the saw chain and guide bar, clean them and spray with corrosion inhibiting oil.
- Thoroughly clean the machine, especially the cooling air inlets.
- If you use a biological chain and bar lubricant, e.g. STIHL BioPlus, completely fill the chain oil tank.
- Store the machine in a dry and secure location – out of the reach of children and other unauthorized persons.

Checking and Replacing the Chain Sprocket

- Disconnect the plug from the wall outlet.
- Remove the chain sprocket cover, chain and guide bar.

Replace the chain sprocket

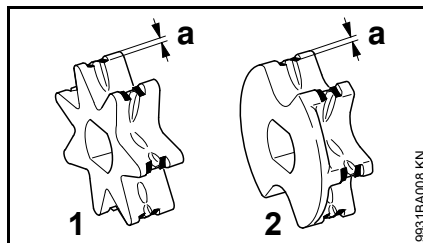

- 1 7-tooth sprocket (MSE 210 C, MSE 230 C)
 - 2 6-tooth sprocket with washer (MSE 170 C, MSE 190 C)
- after using two saw chains or sooner
 - if the wear marks (a) on the sprocket are deeper than 0.5 mm – the life of the chain would otherwise be reduced. Use reference gauge (special accessory) to check the depth of the wear marks.

It is best to use two saw chains in rotation with one sprocket.

STIHL recommends the use of original STIHL sprockets to ensure correct operation of the chain brake.

MSE 170 C and MSE 190 C

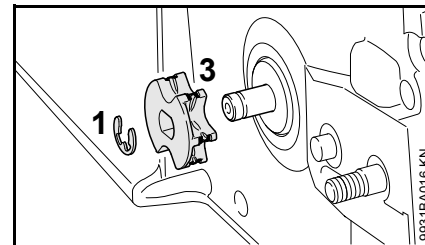

- Ease the E-clip (1) off the shaft.
- Remove and inspect the washer (3) – replace it if it shows signs of wear.
- Install the new chain sprocket in the reverse sequence.

MSE 210 C and MSE 230 C

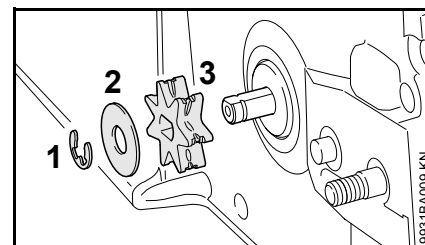

- Ease the E-clip (1) off the shaft.
- Remove and inspect the washer (2) – replace it if it shows signs of wear.
- Remove the chain sprocket (3).
- Install the new chain sprocket in the reverse sequence.

Maintaining and Sharpening the Saw Chain

Cutting effortlessly with a correctly sharpened chain

A properly sharpened chain slices through wood effortlessly and requires very little feed pressure.

Do not work with a dull or damaged chain as it will increase the physical effort required, produce unsatisfactory results and a higher rate of wear.

- Clean the chain.
- Check the chain for cracks in the links and damaged rivets.
- Replace any damaged or worn parts of the chain and match the new parts to the shape and size of the original parts.

Carbide-tipped saw chains (Duro) are particularly wear resistant. STIHL recommends you have your chain resharpened by a STIHL servicing dealer.

WARNING

It is absolutely essential to comply with the angles and dimensions specified below. If the saw chain is incorrectly sharpened – and in particular if the depth gauge is set too low – there is a risk of increased kickback of the saw, with resulting **risk of injury**.

Chain pitch

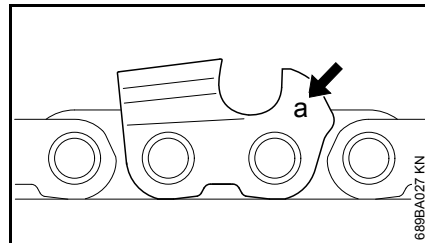

The chain pitch (**a**) is marked on the depth gauge end of each cutter.

Mark (a)	Chain pitch	
	inch	mm
7	1/4 P	6.35
1 or 1/4	1/4	6.35
6, P or PM	3/8 P	9.32
2 or 3/25	0.325	8.25
3 or 3/8	3/8	9.32
4 or 4/4	0.404	10.26

Select file diameter according to chain pitch – see table “Sharpening Tools”.

You must observe certain angles when resharpening the chain cutter.

Filing and side plate angles

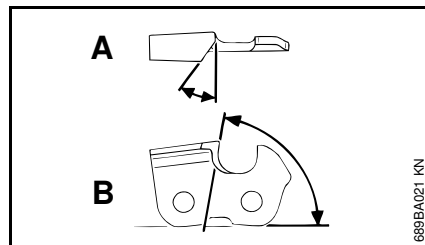

A Filing angle

STIHL saw chains are sharpened to a filing angle of 30°. Exceptions are ripping chains with a filing angle of 10°. Ripping chains have an X in their designations.

B Side plate angle

The correct side plate angle is obtained automatically if you use the prescribed file holder and file diameter.

Cutter shapes	Angle (°)	
	A	B
Micro = semi chisel cutter, e.g. 63 PM3, 26 RM3, 36 RM	30	75
Super = chisel cutter, e.g. 63 PS3, 26 RS, 36 RS3	30	60
Ripping chain, e.g. 63 PMX, 36 RMX	10	75

The angles must be the same on all cutters. If the angles are uneven: Chain will run roughly, not in a straight line, wear quickly and finally break.

File holder

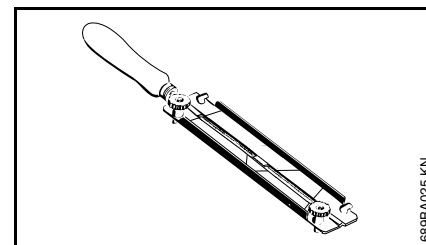

● Use a file holder

A file holder must be used for manual resharpening (see table “Sharpening Tools”). The correct filing angles are marked on the file holder.

Use only special saw chain sharpening files. Other files have the wrong shape and cut.

For checking angles

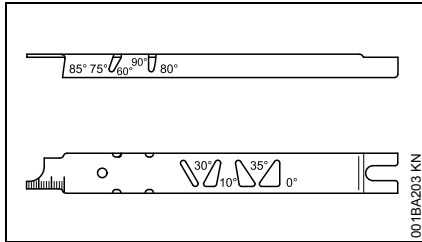

Use a STIHL filing gauge (special accessory, see table "Sharpening Tools"). This is a universal tool for checking the filing and side plate angles, depth gauge setting, cutter length and groove depth. It also cleans the guide bar groove and oil inlet holes.

File correctly

- Disconnect the plug from the wall outlet.
- Select sharpening tools according to chain pitch.
- Clamp the bar in a vise if necessary.
- To rotate the chain – pull hand guard against handle to disengage the chain brake. Hold the hand guard in this position – the coasting brake is disengaged.
- Sharpen the chain frequently, take away as little metal as possible – two or three strokes of the file are usually enough.

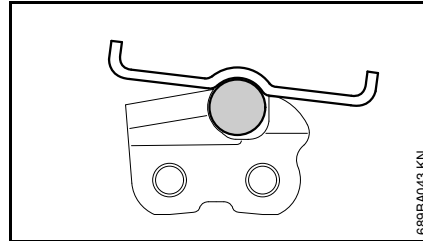
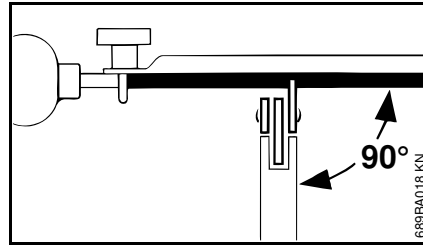

- Hold the file **horizontally** (at a right angle to the side of the guide bar) and file according to the angles marked on the file holder. Rest the file holder on the top plate and depth gauge.
 - Always file from the inside to the outside of the cutter.
 - The file only sharpens on the forward stroke – lift the file off the cutter on the backstroke.
 - Avoid touching the tie straps and drive links with the file.
 - Rotate the file at regular intervals while filing to avoid one-sided wear.
 - Use a piece of hardwood to remove burrs from the cutting edge.
 - Check angles with the filing gauge.
- All cutters must be the same length.

If the cutters are not the same length, they will have different heights. This makes the chain run roughly and can cause it to break.

- Find the shortest cutter and then file all other cutters back to the same length. It is best to have this work done by a servicing dealer on an electric grinder.

Depth gauge setting

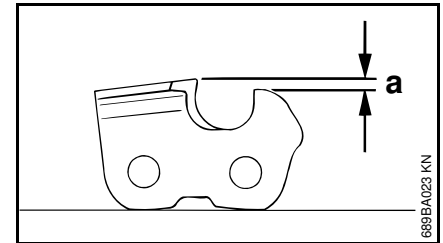

The depth gauge determines the height at which the cutter enters the wood and thus the thickness of the chip removed.

- a** Specified distance or setting between depth gauge and cutting edge.

This setting may be increased by 0.2 mm (0.008") for cutting softwood in the mild weather season – no frost.

Chain pitch		Depth gauge Setting (a)	
inch	(mm)	mm	(inch)
1/4 P	(6.35)	0.45	(0.018)
1/4	(6.35)	0.65	(0.026)
3/8 P	(9.32)	0.65	(0.026)
0.325	(8.25)	0.65	(0.026)
3/8	(9.32)	0.65	(0.026)
0.404	(10.26)	0.80	(0.031)

Lowering depth gauges

The depth gauge setting is reduced when the chain is sharpened.

- Use a filing gauge to check the setting every time you sharpen the chain.

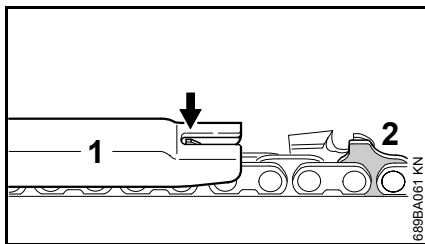

- Place a filing gauge (1) that matches the chain pitch on the chain and press it against the cutter – if the depth gauge projects from the filing gauge, the depth gauge has to be lowered.

Saw chains with humped drive link (2) – upper part of humped drive link (2) (with service mark) is lowered along with the depth gauge.

WARNING

The other parts of the humped drive link must not be filed since this may increase the kickback tendency of the saw.

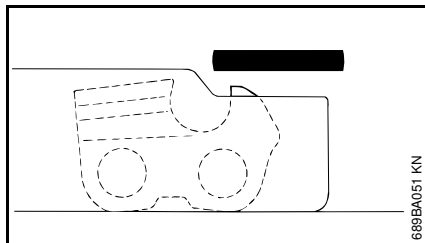

- File down the depth gauge until it is level with the filing gauge.

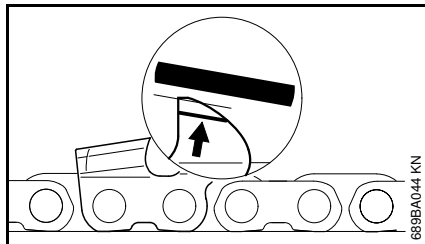

- File the top of the depth gauge parallel to the stamped service marking (see arrow) – but do not lower the highest point of the depth gauge in this process.

WARNING

The kickback tendency of the saw is increased if the depth gauges are too low.

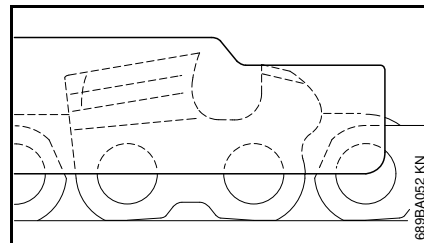

- Place the filing gauge on the chain – the highest point of the depth gauge must be level with the filing gauge.
- After sharpening, clean the chain thoroughly, remove filings or grinding dust – lubricate the chain thoroughly.
- Before a long out-of-service period, clean the chain and store it in a well-oiled condition.

Sharpening Tools (special accessories)

Chain pitch		Round file Ø		Round file	File holder	Filing gauge	Flat file	Sharpening kit ¹⁾
inch	(mm)	mm	(inch)	Part No.	Part No.	Part No.	Part No.	Part No.
1/4 P	(6.35)	3.2	(1/8)	5605 771 3206	5605 750 4300	0000 893 4005	0814 252 3356	5605 007 1000
1/4	(6.35)	4.0	(5/32)	5605 772 4006	5605 750 4327	1110 893 4000	0814 252 3356	5605 007 1027
3/8 P	(9.32)	4.0	(5/32)	5605 772 4006	5605 750 4327	1110 893 4000	0814 252 3356	5605 007 1027
0.325	(8.25)	4.8	(3/16)	5605 772 4806	5605 750 4328	1110 893 4000	0814 252 3356	5605 007 1028
3/8	(9.32)	5.2	(13/64)	5605 772 5206	5605 750 4329	1110 893 4000	0814 252 3356	5605 007 1029
0.404	(10.26)	5.5	(7/32)	5605 772 5506	5605 750 4330	1106 893 4000	0814 252 3356	5605 007 1030

¹⁾ consisting of file holder with round file, flat file and filing gauge

Maintenance and Care

The following maintenance intervals apply for normal operating conditions only. If your daily working time is longer or operating conditions are difficult (very dusty work area, resin-rich wood, tropical wood, etc.), shorten the specified intervals accordingly.		before starting work	after finishing work or daily	weekly	monthly	if problem	if damaged	if required
Complete machine	Visual inspection (condition, leaks)	X						
	Clean		X					
Trigger switch	Check operation	X						
Chain brake, coasting brake	Check operation	X						
	Check ^{1) 2)}							X
Chain oil tank	Clean				X			
Chain Lubrication	Check	X						
Saw chain	Inspect, also check sharpness	X						
	Check chain tension	X						
	Sharpen							X
Guide bar	Check (wear, damage)	X						
	Clean and turn over			X		X		
	Deburr			X				
	Replace						X	X
Chain sprocket	Check			X				
Cooling inlets	Clean		X					
All accessible screws and nuts	Retighten							X
Chain catcher on sprocket cover	Check			X				
	Replace sprocket cover						X	
Power cord	Check	X						
	Replace ¹⁾						X	
Safety labels	Replace						X	

¹⁾STIHL recommends a STIHL servicing dealer.

²⁾ see chapter on "Chain Brake"

Minimize Wear and Avoid Damage

Observing the instructions in this manual helps reduce the risk of unnecessary wear and damage to the power tool.

The power tool must be operated, maintained and stored with the due care and attention described in this instruction manual.

The user is responsible for all damage caused by non-observance of the safety precautions, operating and maintenance instructions in this manual. This includes in particular:

- Alterations or modifications to the product not approved by STIHL.
- Using tools or accessories which are neither approved or suitable for the product or are of a poor quality.
- Using the product for purposes for which it was not designed.
- Using the product for sports or competitive events.
- Consequential damage caused by continuing to use the product with defective components.

Maintenance Work

All the operations described in the "Maintenance Chart" must be performed on a regular basis. If these maintenance operations cannot be performed by the owner, they should be performed by a servicing dealer.

STIHL recommends that you have servicing and repair work carried out exclusively by an authorized STIHL

servicing dealer. STIHL dealers are regularly given the opportunity to attend training courses and are supplied with the necessary technical information.

If these maintenance operations are not carried out as specified, the user assumes responsibility for any damage that may occur. Among other things, this includes:

- Damage to the motor due to neglect or deficient maintenance (e.g. not cleaning cooling air inlets).
- Damage due to incorrect electrical connection (voltage, inadequately rated connecting cords).
- Corrosion and other consequential damage resulting from improper storage.
- Damage to the product resulting from the use of poor quality replacement parts.

Parts Subject to Wear and Tear

Some parts of the power tool are subject to normal wear and tear even during regular operation in accordance with instructions and, depending on the type and duration of use, have to be replaced in good time. Among other parts, this includes:

- Saw chain, guide bar, chain sprocket.
- Carbon brushes.

Main Parts

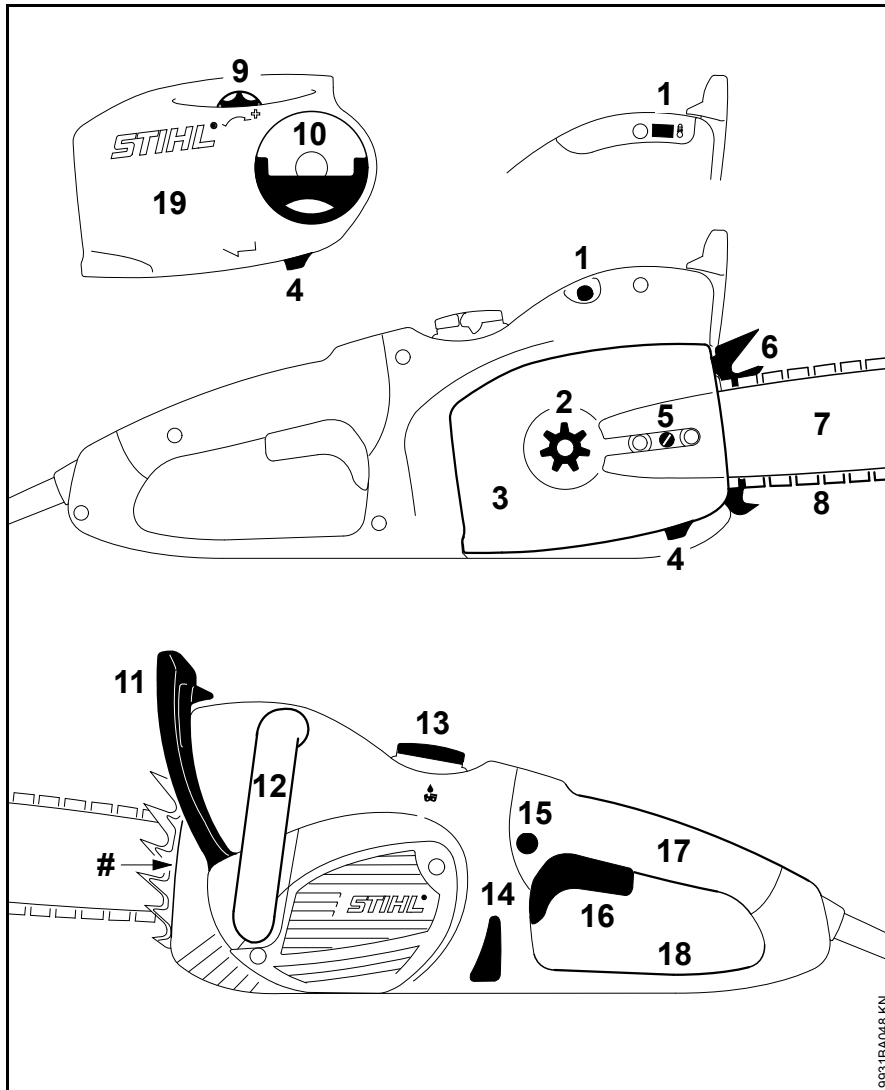

- 1 Overload circuit breaker (MSE 170 C, 190 C, 210 C)
Indicator lamp, electronic overload cutout (MSE 230 C)
- 2 Chain sprocket
- 3 Chain sprocket cover
- 4 Chain catcher
- 5 Side chain tensioner¹⁾
- 6 Spiked bumper
- 7 Guide bar
- 8 Oilomatic chain
- 9 Adjusting wheel¹⁾ (quick chain adjuster)
- 10 Handle of wingnut¹⁾ (quick chain tensioner)
- 11 Front hand guard
- 12 Front handle (handlebar)
- 13 Oil filler cap
- 14 Oil inspection window
- 15 Lockout button
- 16 Trigger
- 17 Rear handle
- 18 Rear hand guard
- 19 Chain sprocket cover (quick chain tensioner)
- # Serial number

¹⁾ Depending on model

Specifications

Motor

MSE 170 C, 230 V version

Voltage:	230 V
Frequency:	50 Hz
Power consumption:	1.7 kW
Fuse:	16 A
Z _{max} *:	0.34 Ω
Type of enclosure:	IP 20
Insulation:	II, 

MSE 170 C, 220 V version

Voltage:	220 V
Frequency:	60 Hz
Power consumption:	1.7 kW
Fuse:	16 A
Z _{max} *:	no limit
Type of enclosure:	IP 20
Insulation:	II, 

MSE 170 C, 100 V version

Voltage:	100 V
Frequency:	50-60 Hz
Rated current:	13.1 A
Z _{max} *:	no limit
Type of enclosure:	IP 20
Insulation:	II, 

MSE 170 C, 127 V version

Voltage:	127 V
Frequency:	60 Hz
Power consumption:	1.7 kW

Fuse:	15 A
Z _{max} *:	no limit
Type of enclosure:	IP 20
Insulation:	II, 

MSE 190 C

Voltage:	230 V
Frequency:	50 Hz
Power consumption:	1.9 kW
Fuse:	16 A
Z _{max} *:	0.34 Ω
Type of enclosure:	IP 20
Insulation:	II, 

MSE 210 C, 230 V version

Voltage:	230 V
Frequency:	50 Hz
Power consumption:	2.1 kW
Fuse:	16 A
Z _{max} *:	0.34 Ω
Type of enclosure:	IP 20
Insulation:	II, 

MSE 210 C, 100 V version

Voltage:	100 V
Frequency:	50-60 Hz
Rated current:	15 A
Z _{max} *:	no limit
Type of enclosure:	IP 20
Insulation:	II, 

MSE 230 C, 230 V version

Voltage:	230 V
Frequency:	50 Hz
Power consumption:	2.3 kW
Fuse:	16 A

Z _{max} *:	no limit
Type of enclosure:	IP 20
Insulation:	II, 

MSE 230 C, 230 V version for Switzerland

Voltage:	230 V
Frequency:	50 Hz
Rated current:	10 A
Fuse:	10 A
Z _{max} *:	no limit
Type of enclosure:	IP 20
Insulation:	II, 

* maximum permissible service connection impedance

Chain Lubrication

Fully automatic speed-controlled oil pump with reciprocating piston

Oil tank capacity: 200 cc (0.2 l)

Weight

with bar and chain, without cord	
MSE 170 C:	4.2 kg
MS 170 C with quick chain adjuster:	4.3 kg
MSE 190 C:	4.4 kg
MS 190 C with quick chain adjuster:	4.5 kg
MSE 210 C:	4.6 kg
MSE 230 C:	4.8 kg

Cutting Attachment (MSE 170 C)

Actual cutting length may be less than the specified length

Rollomatic E Mini Light guide bars

Cutting lengths: 25, 30, 35 cm
3/8" P
Pitch: (9.32 mm)
Groove width: 1.1 mm
Nose sprocket: 7-tooth

Rollomatic E Mini guide bars

Cutting lengths: 30, 35, 40 cm
3/8" P
Pitch: (9.32 mm)
Groove width: 1.1 mm
Nose sprocket: 7-tooth

3/8" Picco chain

Picco Micro Mini 3 (61 PMM3)
Type 3610
Pitch: 3/8" P
(9.32 mm)
Drive link gauge: 1.1 mm

Rollomatic E guide bars

Cutting lengths: 30, 35, 40 cm
3/8" P
Pitch: (9.32 mm)
Groove width: 1.3 mm
Nose sprocket: 9-tooth

3/8" Picco chain

Picco Micro 3 (63 PM3) Type 3636
Picco Duro 3 (63 PD3) Type 3612
Pitch: 3/8" P
(9.32 mm)
Drive link gauge: 1.3 mm

Carving guide bars

Cutting lengths: 25, 30 cm
Pitch: 1/4" (6.35 mm)
Groove width: 1.3 mm

1/4" chains

Rapid Micro Spezial (13 RMS)
Type 3661
Pitch: 1/4" (6.35 mm)
Drive link gauge: 1.3 mm

Chain sprocket

6-tooth for 3/8" P
8-tooth for 1/4"

Cutting Attachment (MSE 190 C, MSE 210 C, MSE 230 C)

Actual cutting length may be less than the specified length

Rollomatic E Light and Rollomatic E guide bars

Cutting lengths: 30, 35, 40 cm
3/8" P
Pitch: (9.32 mm)
Groove width: 1.3 mm
Nose sprocket: 9-tooth

3/8" Picco chain

Picco Micro 3 (63 PM3) Type 3636
Picco Duro 3 (63 PD3) Type 3612
Pitch: 3/8" P
(9.32 mm)
Drive link gauge: 1.3 mm

Rollomatic E guide bars

Cutting lengths: 45 cm
3/8" P
Pitch: (9.32 mm)
Groove width: 1.3 mm
Nose sprocket: 9-tooth

3/8" Picco chain

Picco Micro 3 (63 PM3) Type 3636
Pitch: 3/8" P
(9.32 mm)
Drive link gauge: 1.3 mm

Carving guide bars

Cutting lengths: 25, 30 cm
Pitch: 1/4" (6.35 mm)
Groove width: 1.3 mm

1/4" chains

Rapid Micro Spezial (13 RMS)
Type 3661
Pitch: 1/4" (6.35 mm)
Drive link gauge: 1.3 mm

Chain sprocket**MSE 190 C**

6-tooth for 3/8" P
8-tooth for 1/4"

MSE 210 C and MSE 230 C

7-tooth for 3/8" P

8-tooth for 1/4"

Noise and Vibration Data

Noise data is determined on the basis of the rated maximum speed.

Vibration data is determined on the basis of the full load operating mode.

For further details on compliance with Vibration Directive 2002/44/EC see www.stihl.com/vib.

Sound pressure level L_p to EN 60745-2-13

MSE 170 C:	92 dB(A)
MSE 190 C:	92 dB(A)
MSE 210 C:	93 dB(A)
MSE 230 C:	93 dB(A)

Sound power level L_w to EN 60745-2-13

MSE 170 C:	103 dB(A)
MSE 190 C:	103 dB(A)
MSE 210 C:	104 dB(A)
MSE 230 C:	104 dB(A)

Vibration measurement a_{hv} to EN 60745-2-13

	Handle, left	Handle, right
MSE 170 C:	2.9 m/s ²	3.4 m/s ²
MSE 190 C:	2.9 m/s ²	3.4 m/s ²
MSE 210 C:	3.4 m/s ²	4.2 m/s ²
MSE 230 C:	3.4 m/s ²	4.2 m/s ²

The K-factor in accordance with Directive 2006/42/EC is 2.0 dB(A) for the sound pressure level and sound power level; the K-factor in accordance with Directive 2006/42/EC is 2.0 m/s² for the vibration level.

The vibration values quoted above have been measured according to a standardized test procedure and may be used to compare electric power tools.

Depending on the type of usage, the vibrations that actually occur may differ from the values quoted.

The vibration values quoted may be used for an initial assessment of the user's exposure to vibrations.

The actual exposure to vibrations has to be evaluated. This process may also take into account times during which the electric power tool is switched off and times during which it is switched on but running without load.

Observe measures to reduce vibration exposure to protect the user – see section on "Vibrations" in chapter on "Safety Precautions and Working Techniques".

REACH

REACH is an EC regulation and stands for the Registration, Evaluation, Authorisation and Restriction of Chemical substances.

For information on compliance with the REACH regulation (EC) No. 1907/2006 see www.stihl.com/reach.

Ordering Spare Parts

Please enter your saw model, serial number as well as the part numbers of the guide bar and saw chain in the spaces provided. This will make re-ordering simpler.

The guide bar and saw chain are subject to normal wear and tear. When purchasing these parts, always quote the saw model, the part numbers and names of the parts.

Model

Serial number

Guide bar part number

Chain part number

Maintenance and Repairs

Users of this machine may only carry out the maintenance and service work described in this user manual. All other repairs must be carried out by a servicing dealer.

STIHL recommends that you have servicing and repair work carried out exclusively by an authorized STIHL servicing dealer. STIHL dealers are regularly given the opportunity to attend training courses and are supplied with the necessary technical information.

When repairing the machine, only use replacement parts which have been approved by STIHL for this power tool or are technically identical. Only use high-quality replacement parts in order to avoid the risk of accidents and damage to the machine.

STIHL recommends the use of original STIHL replacement parts.

Original STIHL parts can be identified by the STIHL part number, the **STIHL** logo and the STIHL parts symbol  (the symbol may appear alone on small parts).

Disposal

Observe all country-specific waste disposal rules and regulations.

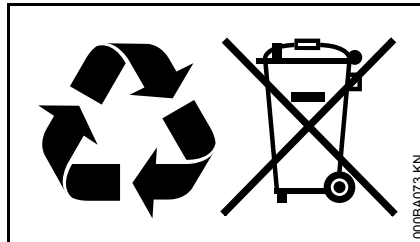

STIHL products must not be thrown in the garbage can. Take the product, accessories and packaging to an approved disposal site for environment-friendly recycling.

Contact your STIHL servicing dealer for the latest information on waste disposal.

EC Declaration of Conformity

ANDREAS STIHL AG & Co. KG
Badstr. 115
D-71336 Waiblingen

Germany

declares under our sole responsibility that

Designation:	Electric saw
Make:	STIHL
Series:	MSE 170 C MSE 170 C-B MSE 190 C MSE 190 C-B MSE 210 C MSE 210 C-B MSE 230 C MSE 230 C-B

Serial identification number: 1209

conforms to the relevant provisions of Directives 2011/65/EU, 2006/42/EC, 2014/30/EU and 2000/14/EC and has been developed and manufactured in compliance with the following standards in the versions valid on the date of production:

EN 60745-1, EN 60745-2-13,
EN 55014-1, EN 55014-2,
EN 61000-3-2, EN 61000-3-3,
EN 61000-3-11

The measured and the guaranteed sound power level have been determined in accordance with Directive 2000/14/EC, Annex V, and standard ISO 22868.

Measured sound power level

all MSE 170 C:	105 dB(A)
all MSE 190 C:	105 dB(A)
all MSE 210 C:	106 dB(A)
all MSE 230 C:	106 dB(A)

Guaranteed sound power level

all MSE 170 C:	106 dB(A)
all MSE 190 C:	106 dB(A)
all MSE 210 C:	107 dB(A)
all MSE 230 C:	107 dB(A)

The EC type examination was carried out by

VDE Prüf- und Zertifizierungsinstitut
(NB 0366)
Merianstrasse 28
D-63069 Offenbach

Certification No.:

all MSE 170 C:	40035918
all MSE 190 C:	40035918
all MSE 210 C:	40035918
all MSE 230 C:	40035918

Technical documents deposited at:

ANDREAS STIHL AG & Co. KG
Produktzulassung

The year of construction, the country of manufacture and the machine number are shown on the machine.

Done at Waiblingen, 03.02.2020

ANDREAS STIHL AG & Co. KG

pp

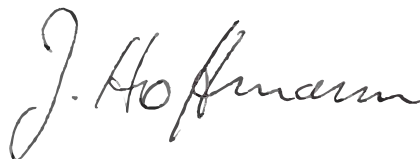

Dr. Jürgen Hoffmann

Head of Product Data, Regulations and
Licensing



General Power Tool Safety Warnings

This chapter reproduces the pre-formulated, general safety precautions specified in the EN 60745 European standard for hand-held motor-operated electric tools. **STIHL is required by law to print these standardized texts verbatim.**

The safety precautions and warnings on avoiding an electric shock given under "2) Electric Precautions" do not apply to STIHL cordless electric power tools

WARNING

Read all safety warnings and instructions. Failure to follow the warnings and instructions may result in electric shock, fire and/or serious injury.

Save all warnings and instructions for future reference.

The term "power tool" in the warnings refers to your mains-operated (corded) power tool or battery-operated (cordless) power tool.

1) Work area safety

- a) **Keep work area clean and well lit.** Cluttered or dark areas invite accidents.
- b) **Do not operate power tools in explosive atmospheres, such as in the presence of flammable liquids, gases or dust.** Power tools create sparks which may ignite the dust or fumes.
- c) **Keep children and bystanders away while operating a power tool.** Distractions can cause you to lose control.

2) Electrical safety

- a) **Power tool plugs must match the outlet. Never modify the plug in any way. Do not use any adapter plugs with earthed (grounded) power tools.** Unmodified plugs and matching outlets will reduce risk of electric shock.
- b) **Avoid body contact with earthed or grounded surfaces, such as pipes, radiators, ranges and refrigerators.** There is an increased risk of electric shock if your body is earthed or grounded.
- c) **Do not expose power tools to rain or wet conditions.** Water entering a power tool will increase the risk of electric shock.

- d) **Do not abuse the cord. Never use the cord for carrying, pulling or unplugging the power tool. Keep cord away from heat, oil, sharp edges or moving parts.** Damaged or entangled cords increase the risk of electric shock.
- e) **When operating a power tool outdoors, use an extension cord suitable for outdoor use.** Use of a cord suitable for outdoor use reduces the risk of electric shock.
- f) **If operating a power tool in a damp location is unavoidable, use a residual current device (RCD) protected supply.** Use of an RCD reduces the risk of electric shock.

3) Personal safety

- a) **Stay alert, watch what you are doing and use common sense when operating a power tool. Do not use a power tool while you are tired or under the influence of drugs, alcohol or medication.** A moment of inattention while operating power tools may result in serious personal injury.
- b) **Use personal protective equipment. Always wear eye protection.** Protective equipment such as dust mask, non-skid safety shoes, hard hat, or hearing protection used for appropriate conditions will reduce personal injuries.

- c) **Prevent unintentional starting. Ensure the switch is in the off-position before connecting to power source and/or battery pack, picking up or carrying the tool.** Carrying power tools with your finger on the switch or energising power tools that have the switch on invites accidents.
- d) **Remove any adjusting key or wrench before turning the power tool on.** A wrench or a key left attached to a rotating part of the power tool may result in personal injury.
- e) **Do not overreach. Keep proper footing and balance at all times.** This enables better control of the power tool in unexpected situations.
- f) **Dress properly. Do not wear loose clothing or jewellery. Keep your hair, clothing and gloves away from moving parts.** Loose clothes, jewellery or long hair can be caught in moving parts.
- g) **If devices are provided for the connection of dust extraction and collection facilities, ensure these are connected and properly used.** Use of dust collection can reduce dust-related hazards.

4) Power tool use and care

- a) **Do not force the power tool. Use the correct power tool for your application.** The correct power tool will do the job better and safer at the rate for which it was designed.
- b) **Do not use the power tool if the switch does not turn it on and off.** Any power tool that cannot be controlled with the switch is dangerous and must be repaired.
- c) **Disconnect the plug from the power source and/or the battery pack from the power tool before making any adjustments, changing accessories, or storing power tools.** Such preventive safety measures reduce the risk of starting the power tool accidentally.
- d) **Store idle power tools out of the reach of children and do not allow persons unfamiliar with the power tool or these instructions to operate the power tool.** Power tools are dangerous in the hands of untrained users.
- e) **Maintain power tools. Check for misalignment or binding of moving parts, breakage of parts and any other condition that may affect the power tool's operation. If damaged, have the power tool repaired before use.** Many accidents are caused by poorly maintained power tools.

- f) **Keep cutting tools sharp and clean.** Properly maintained cutting tools with sharp cutting edges are less likely to bind and are easier to control.
- g) **Use the power tool, accessories, tool bits etc. in accordance with these instructions, taking into account the working conditions and the work to be performed.** Use of the power tool for operations different from those intended could result in a hazardous situation.

5) Service

- a) **Have your power tool serviced by a qualified repair person using only identical replacement parts.** This will ensure that the safety of the power tool is maintained.

Chain saw safety warnings

- **Keep all parts of the body away from the saw chain when the chain saw is operating. Before you start the chain saw, make sure the saw chain is not contacting anything.** A moment of inattention while operating chain saws may cause entanglement of your clothing or body with the saw chain.
- **Always hold the chain saw with your right hand on the rear handle and your left hand on the front handle.** Holding the chain saw with a reversed hand configuration increases the risk of personal injury and should never be done.

- **Hold the power tool by insulated gripping surfaces only, because the saw chain may contact hidden wiring or its own cord.** Saw chains contacting a "live" wire may make exposed metal parts of the power tool "live" and could give the operator an electric shock.
- **Wear safety glasses and hearing protection. Further protective equipment for head, hands, legs and feet is recommended.** Adequate protective clothing will reduce personal injury by flying debris or accidental contact with the saw chain.
- **Do not operate a chain saw in a tree.** Operation of a chain saw while up in a tree may result in personal injury.
- **Always keep proper footing and operate the chain saw only when standing on a fixed, secure and level surface.** Slippery or unstable surfaces such as ladders may cause a loss of balance or control of the chain saw.
- **When cutting a limb that is under tension be alert for spring back.** When the tension in the wood fibres is released the spring loaded limb may strike the operator and/or throw the chain saw out of control.
- **Use extreme caution when cutting brush and saplings.** The slender material may catch the saw chain and be whipped toward you or pull you off balance.

- **Carry the chain saw by the front handle with the chain saw switched off and away from your body. When transporting or storing the chain saw always fit the guide bar cover.** Proper handling of the chain saw will reduce the likelihood of accidental contact with the moving saw chain.
- **Follow instructions for lubricating, chain tensioning and changing accessories.** Improperly tensioned or lubricated chain may either break or increase the chance for kickback.
- **Keep handles dry, clean and free from oil and grease.** Greasy, oily handles are slippery causing loss of control.
- **Cut wood only. Do not use chain saw for purposes not intended. Example: do not use chain saw for cutting plastic, masonry or non-wood building materials.** Use of the chain saw for operations different than intended could result in a hazardous situation.

Causes and operator prevention of kickback:

Kickback may occur when the nose or tip of the guide bar touches an object, or when the wood closes in and pinches the saw chain in the cut.

Tip contact in some cases may cause a sudden reverse reaction, kicking the guide bar up and back towards the operator.

Pinching the saw chain along the top of the guide bar may push the guide bar rapidly back towards the operator.

Either of these reactions may cause you to lose control of the saw which could result in serious personal injury. Do not rely exclusively upon the safety devices built into your saw. As a chain saw user, you should take several steps to keep your cutting jobs free from accident or injury.

Kickback is the result of tool misuse and/or incorrect operating procedures and can be avoided by taking proper precautions as given below:

- **Maintain a firm grip, with thumbs and fingers encircling the chain saw handles, with both hands on the saw and position your body and arm to allow you to resist kickback forces.** Kickback forces can be controlled by the operator, if proper precautions are taken. Do not let go of the chain saw.
- **Do not overreach and do not cut above shoulder height.** This helps prevent unintended tip contact and enables better control of the chain saw in unexpected situations.
- **Only use replacement bars and chains specified by the manufacturer.** Incorrect replacement bars and chains may cause chain breakage and/or kickback.
- **Follow the manufacturer's sharpening and maintenance instructions for the saw chain.** Decreasing the depth gauge height can lead to increased kickback.

0458-756-8021-A

englisch



www.stihl.com



0458-756-8021-A